

C:...\LD\A031N\PR3\PLI003.DAT Kanal 1
 Spannung 100% Bl.stoss Vollwelle
 Max: 125.2kV T1: 1.48us T2: 51.3u

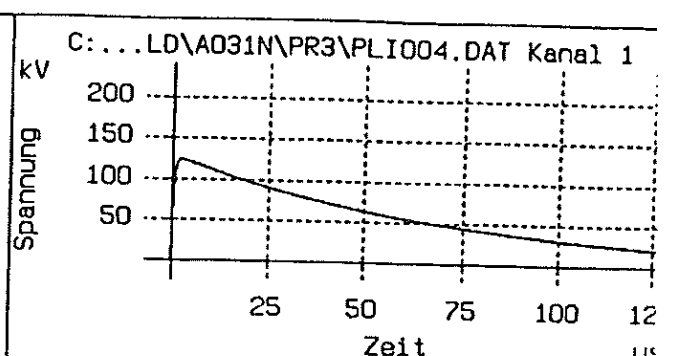

C:...\LD\A031N\PR3\PLI004.DAT Kanal 1
 Spannung 100% Bl.stoss Vollwelle
 Max: 125.2kV T1: 1.472us T2: 51.2

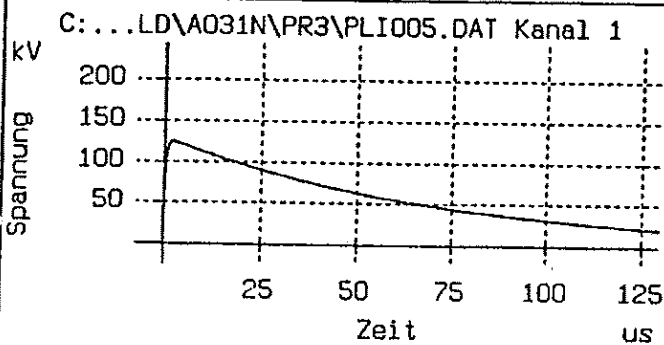

C:...\LD\A031N\PR3\PLI005.DAT Kanal 1
 Spannung 100% Bl.stoss Vollwelle
 Max: 125.2kV T1: 1.495us T2: 51us

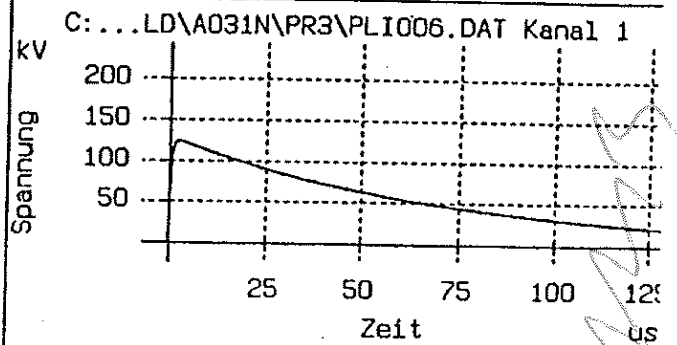

C:...\LD\A031N\PR3\PLI006.DAT Kanal 1
 Spannung 100% Bl.stoss Vollwelle
 Max: 125.2kV T1: 1.494us T2: 51.1

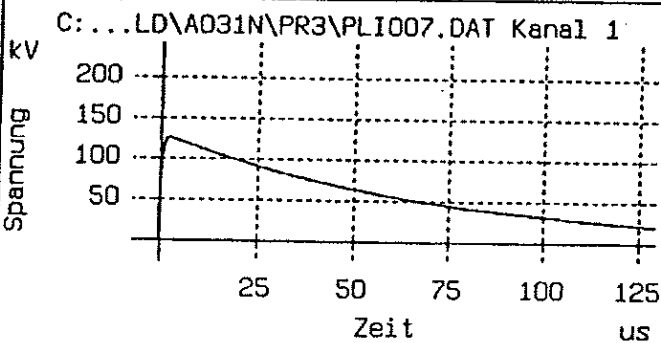

C:...\LD\A031N\PR3\PLI007.DAT Kanal 1
 Spannung 100% Bl.stoss Vollwelle
 Max: 125.2kV T1: 1.491us T2: 51.1

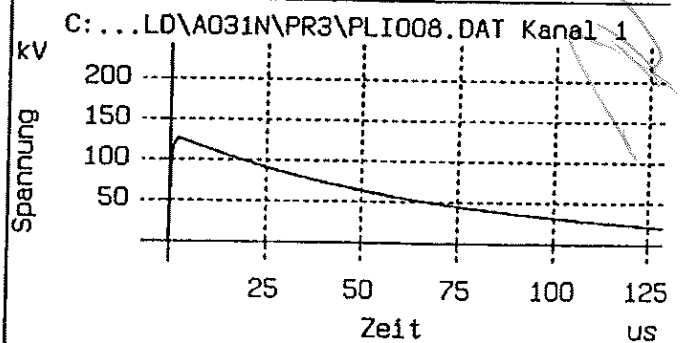

C:...\LD\A031N\PR3\PLI008.DAT Kanal 1
 Spannung 100% Bl.stoss Vollwelle
 Max: 125.2kV T1: 1.517us T2: 51.1

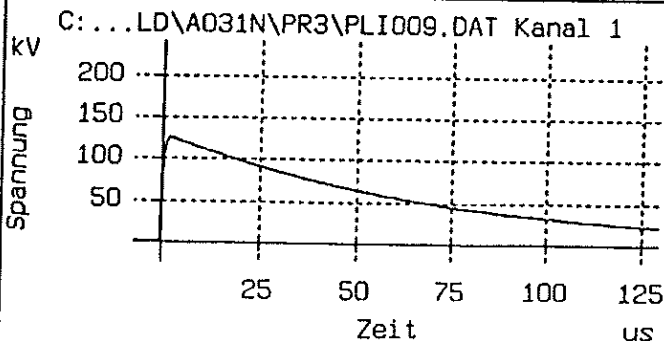

C:...\LD\A031N\PR3\PLI009.DAT Kanal 1
 Spannung 100% Bl.stoss Vollwelle
 Max: 125.4kV T1: 1.508us T2: 51.1

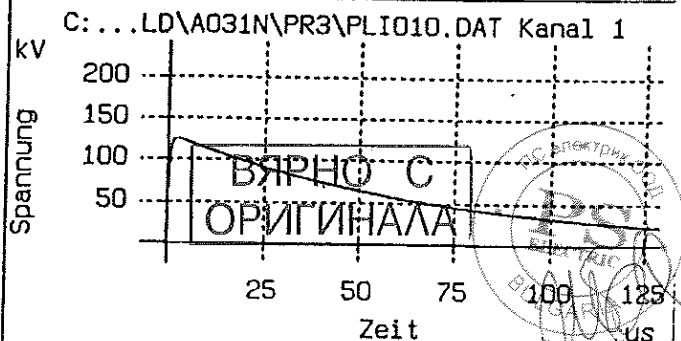

C:...\LD\A031N\PR3\PLI010.DAT Kanal 1
 Spannung 100% Bl.stoss Vollwelle
 Max: 125.2kV T1: 1.494us T2: 51.2

Prüfling K 158 LR , FabNr.:

Kabelstecker



[Handwritten signature]

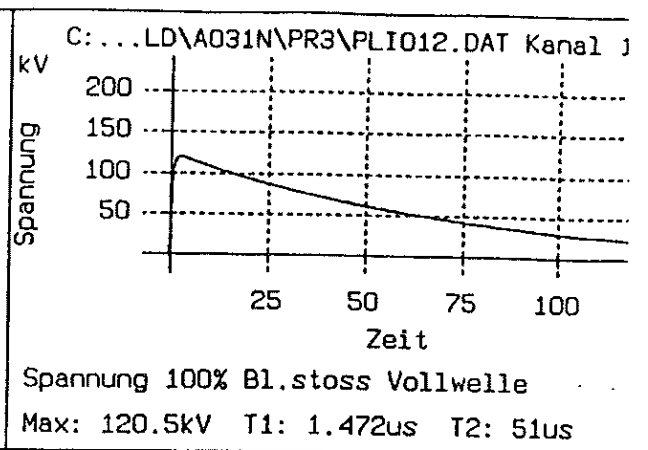
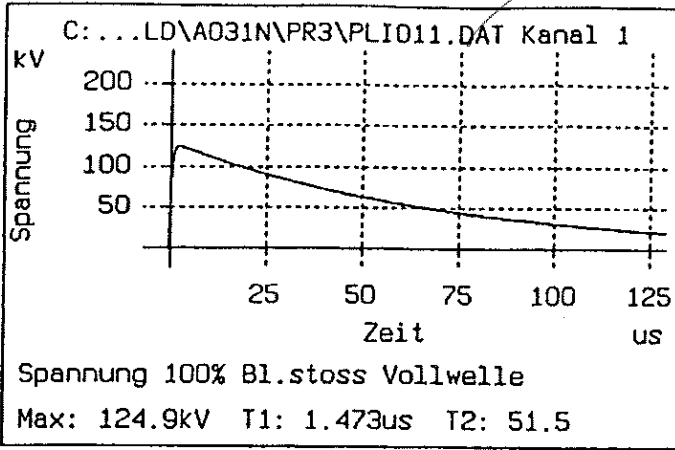

Handwritten signature

**ВЯРНО С
ОРИГИНАЛА**



Prüfling K 158 LR , FabNr.:

Kabelstecker



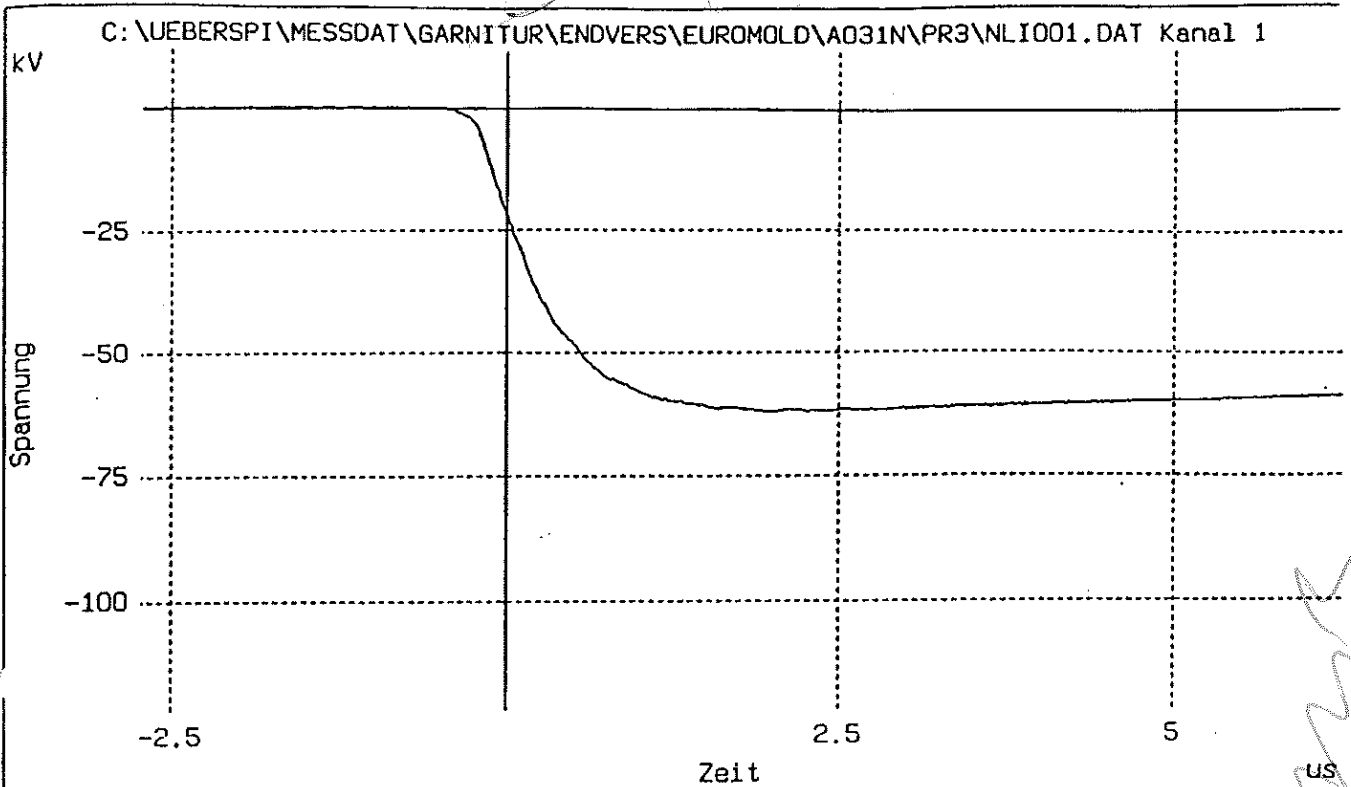

Spannung 50% Bl.stoss Vollwelle
 Max: -62kV T1: 1.473us T2: Oms

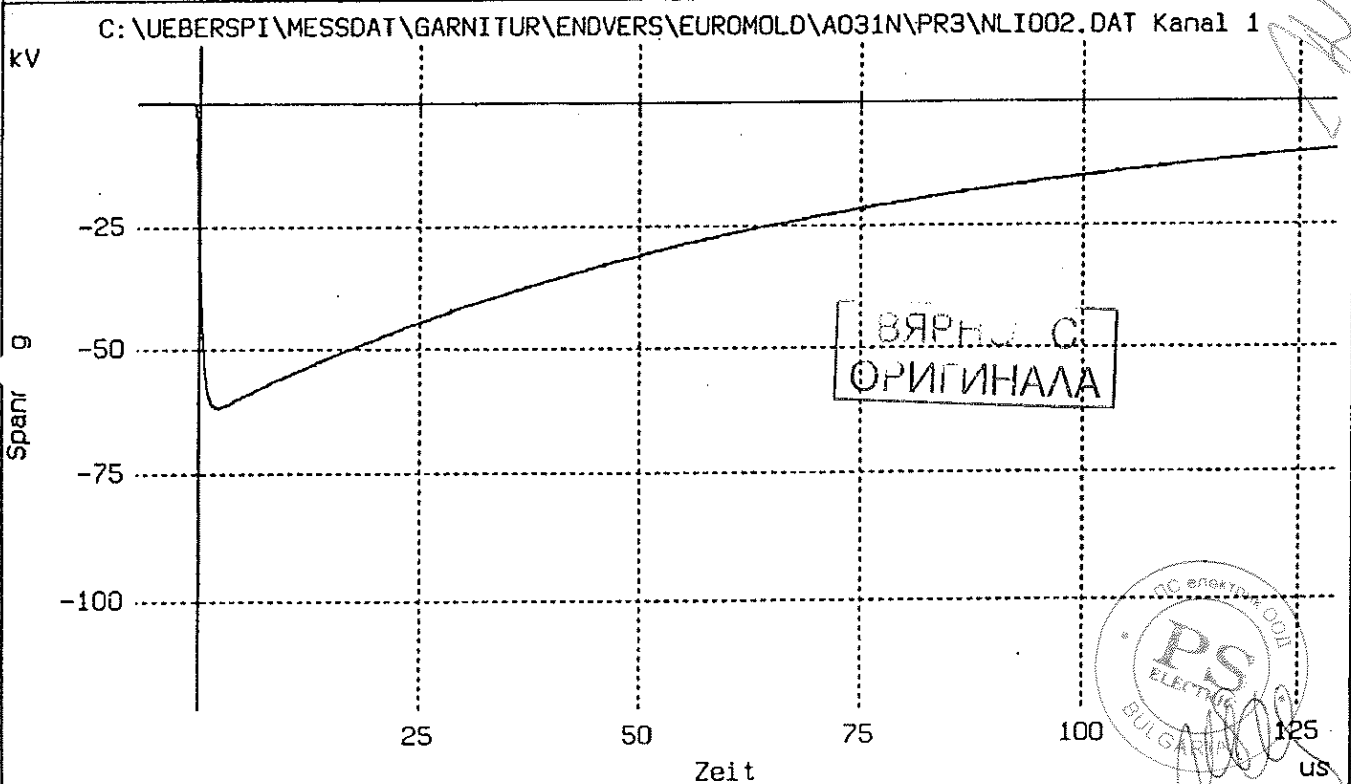

Spannung 50% Bl.stoss Vollwelle
 Max: -62kV T1: 1.49us T2: 50.7us

ВЯРЛИ С
 ОРИГИНАЛА

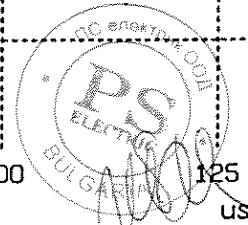

[Handwritten signature]

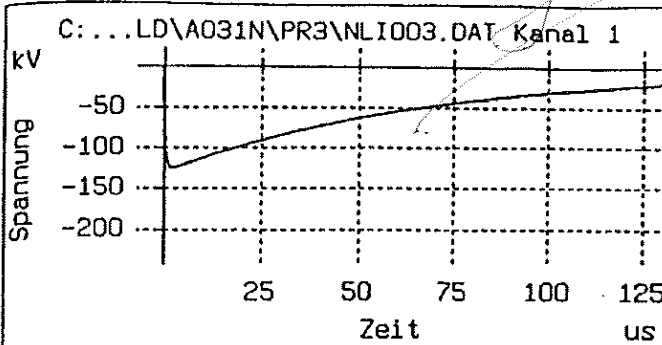

Spannung 100% Bl.stoss Vollwelle
 Max: -125kV T1: 1.51us T2: 50.9us

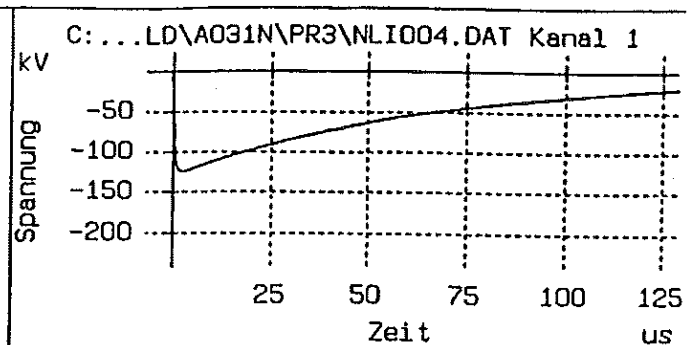

Spannung 100% Bl.stoss Vollwelle
 Max: -125kV T1: 1.527us T2: 50.8u

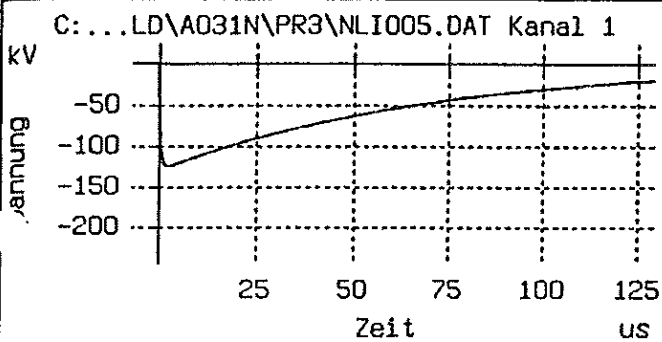

Spannung 100% Bl.stoss Vollwelle
 Max: -124kV T1: 1.464us T2: 51.1u

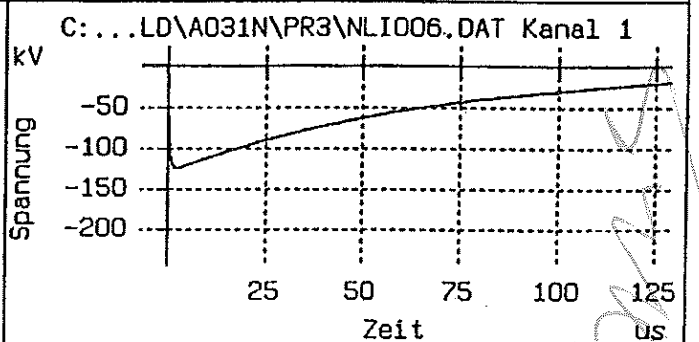

Spannung 100% Bl.stoss Vollwelle
 Max: -124kV T1: 1.486us T2: 51us

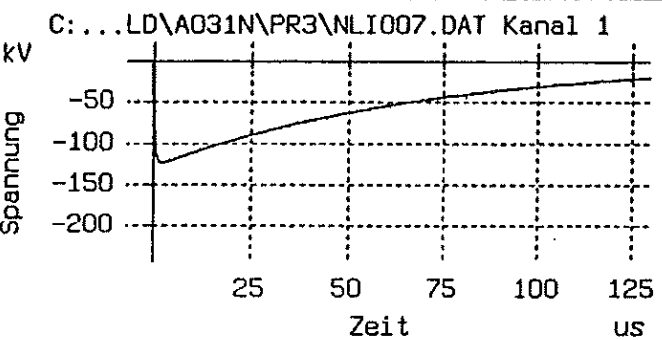

Spannung 100% Bl.stoss Vollwelle
 Max: -125kV T1: 1.489us T2: 51us

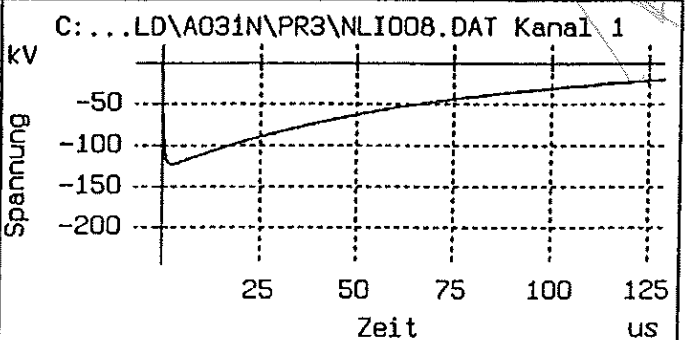

Spannung 100% Bl.stoss Vollwelle
 Max: -125kV T1: 1.459us T2: 51us

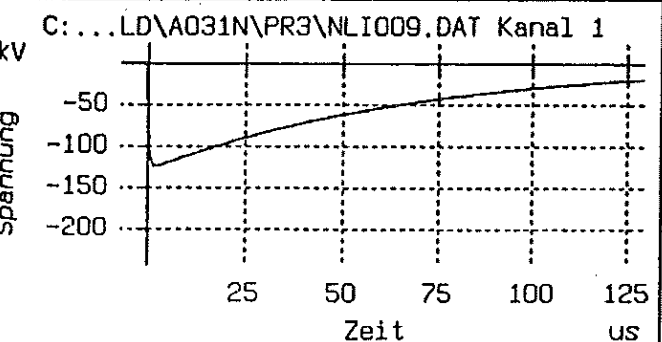

Spannung 100% Bl.stoss Vollwelle
 Max: -125kV T1: 1.462us T2: 50.9u

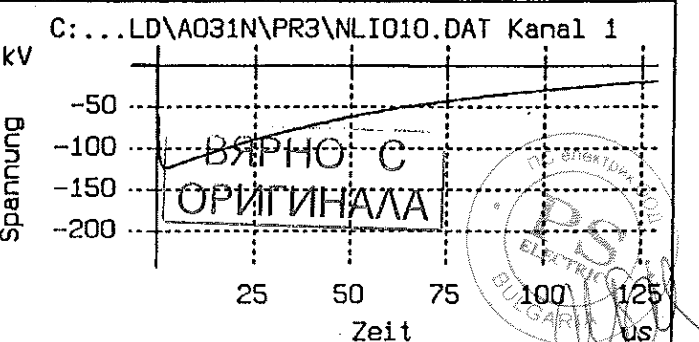

Spannung 100% Bl.stoss Vollwelle
 Max: -125kV T1: 1.472us T2: 51us

Prüfling K 158 LR , FabNr.:

Kabelstecker



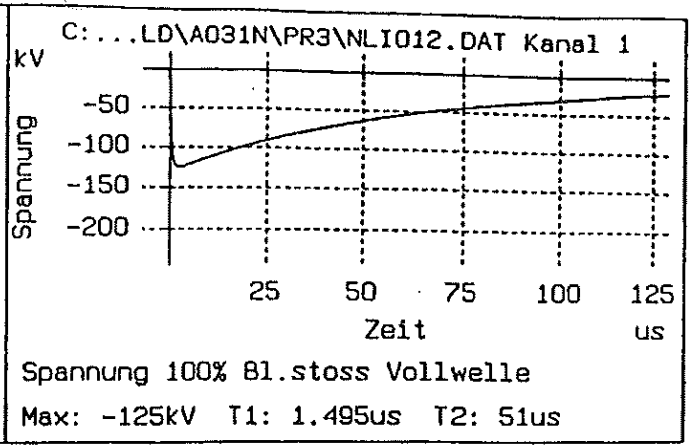
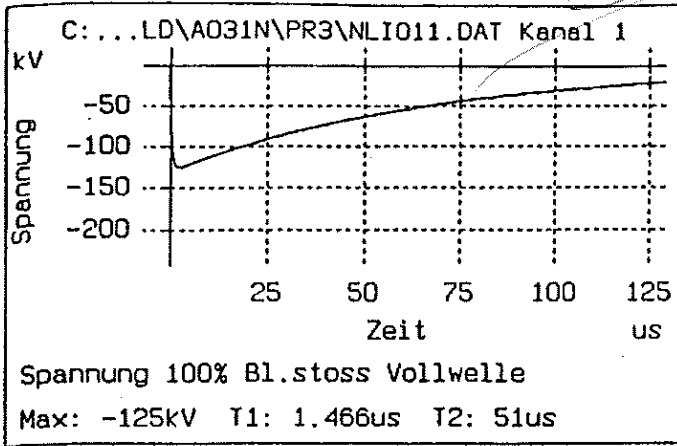

Handwritten signature

ВЯРНО С
ОРИГИНАЛА

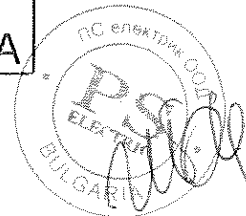

Prüfiling K 158 LR , FabNr.:

Kabelstecker

Handwritten signature



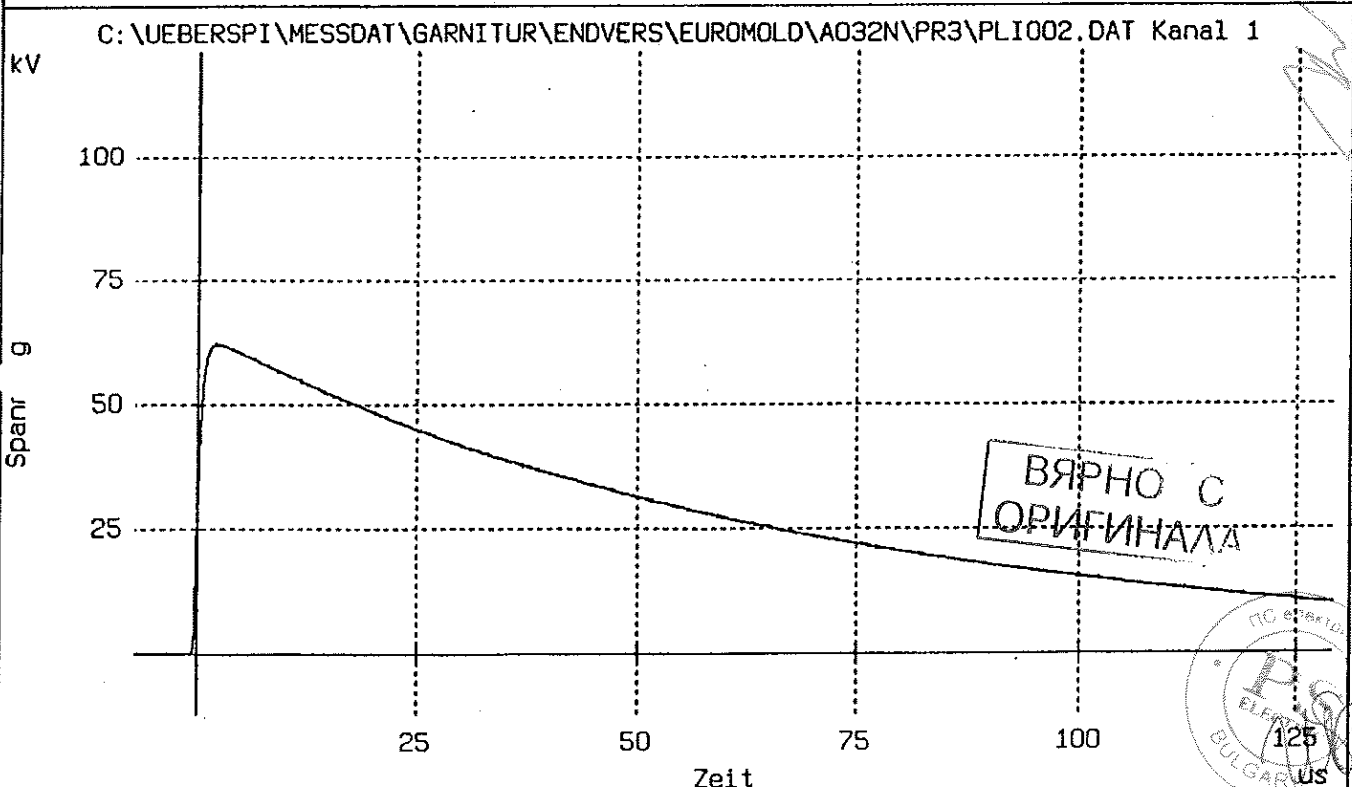
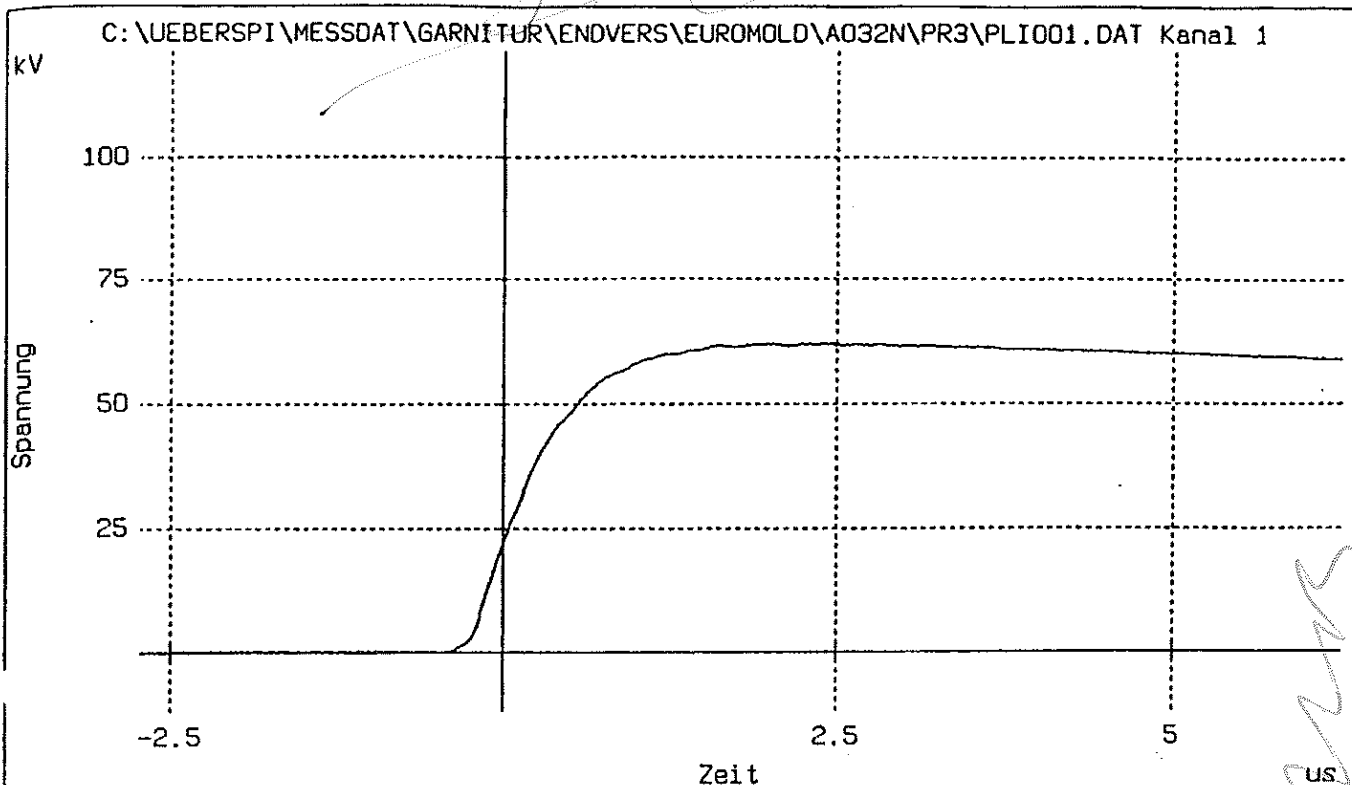

ВЯРНО С
ОРИГИНАЛА

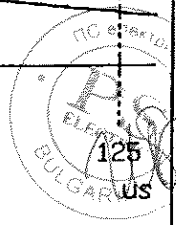

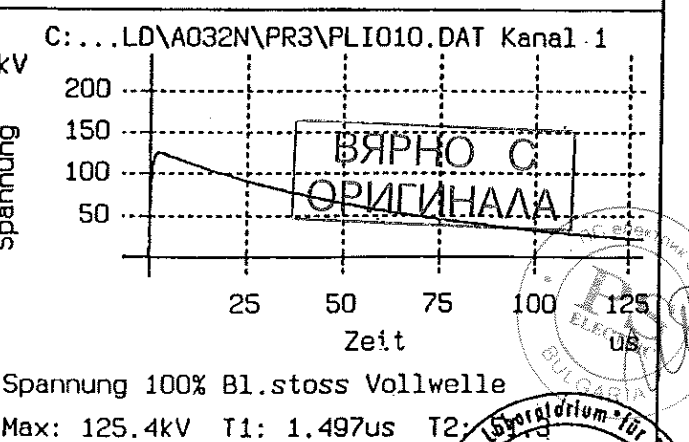
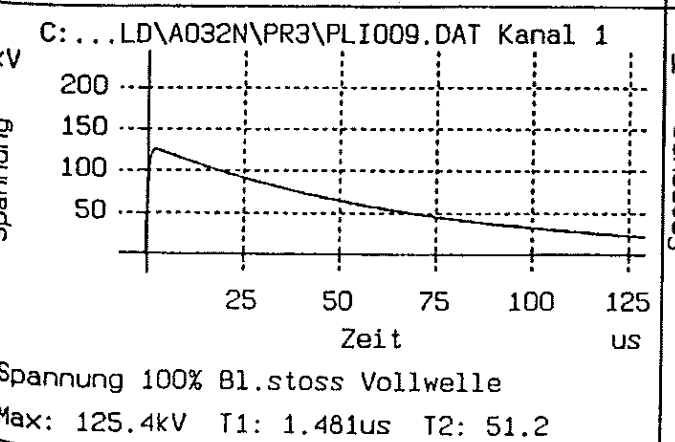
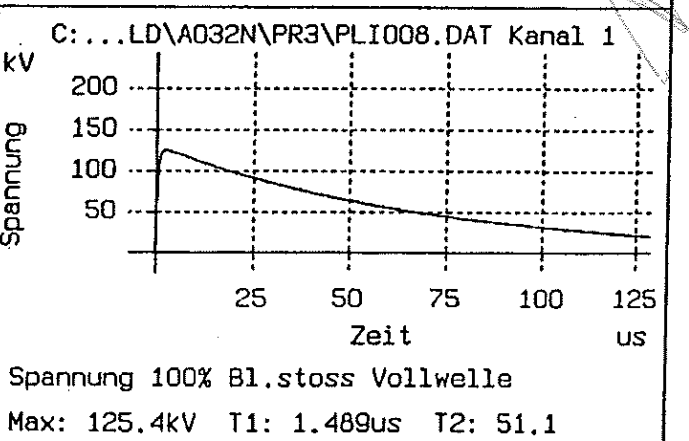
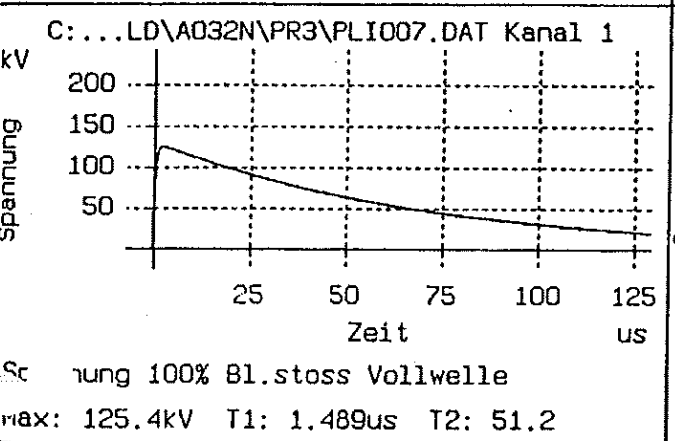
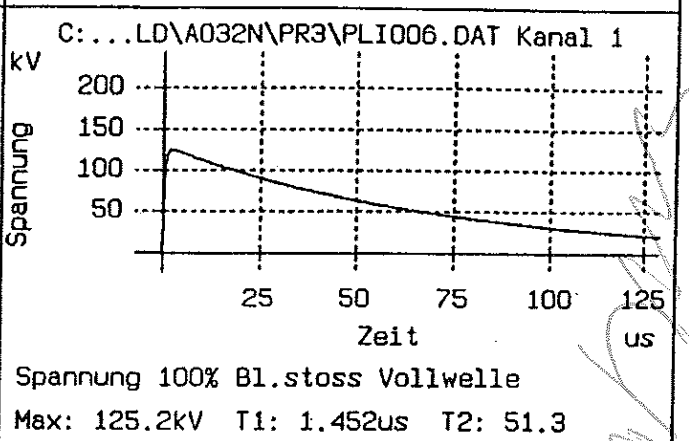
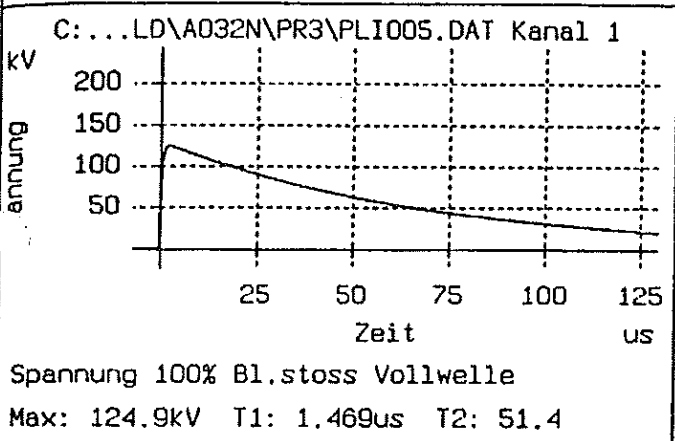
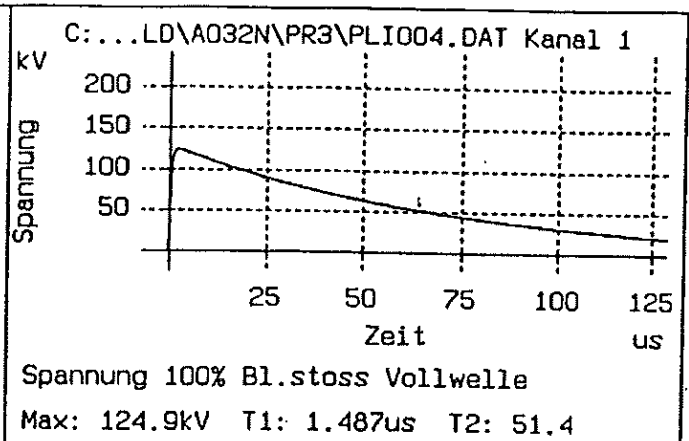
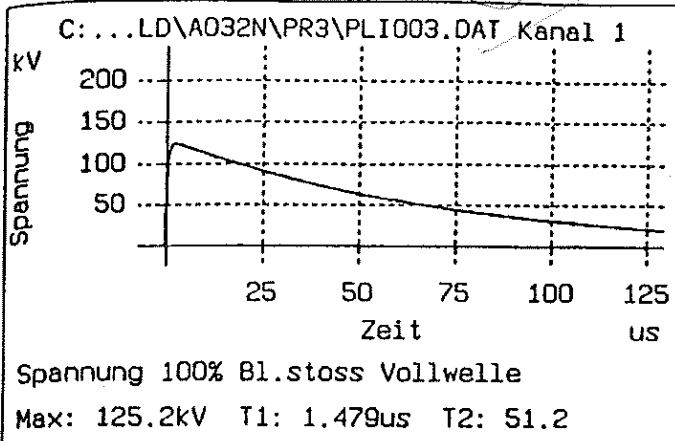

Prüfling K 158 LR , FabNr.:

Kabelstecker

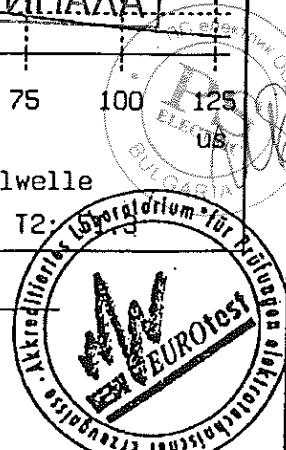

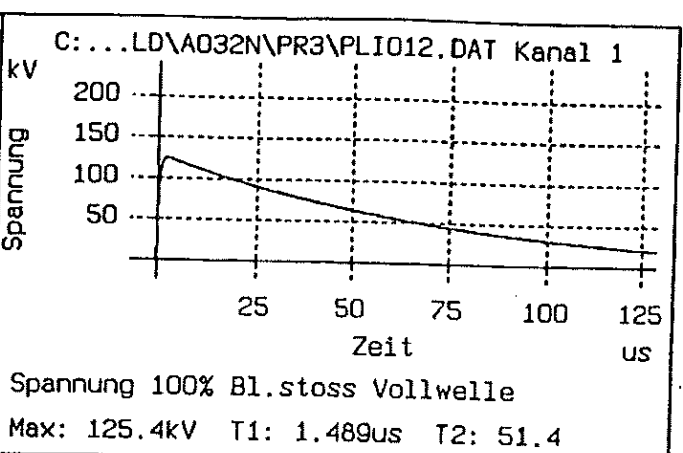
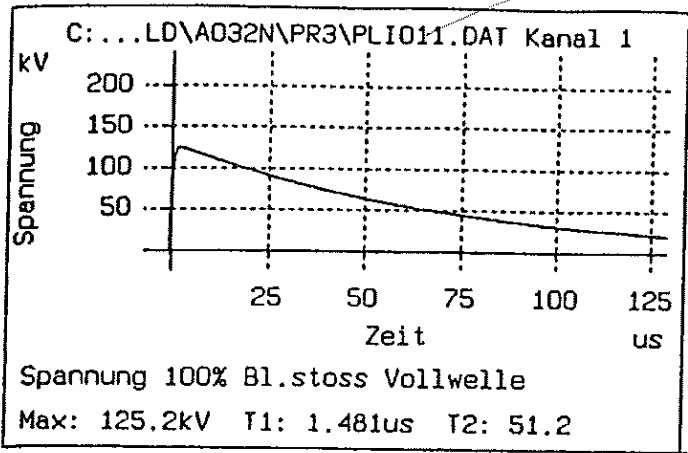

Handwritten signature

ВЯРНО С
ОРИГИНАЛА

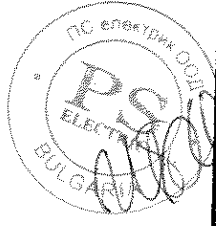

Prüfling K 158 LR , FabNr.:

Kabelstecker



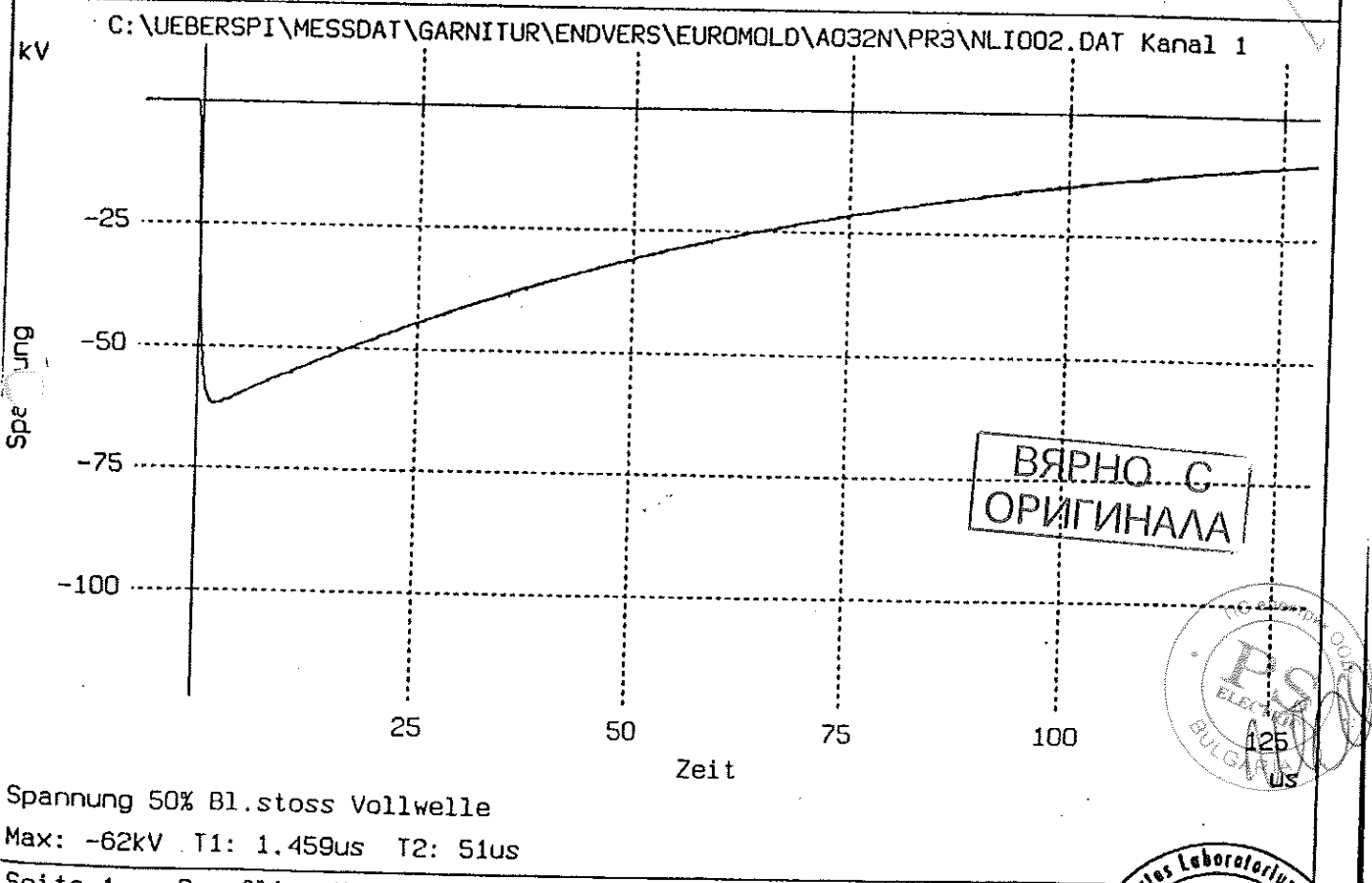
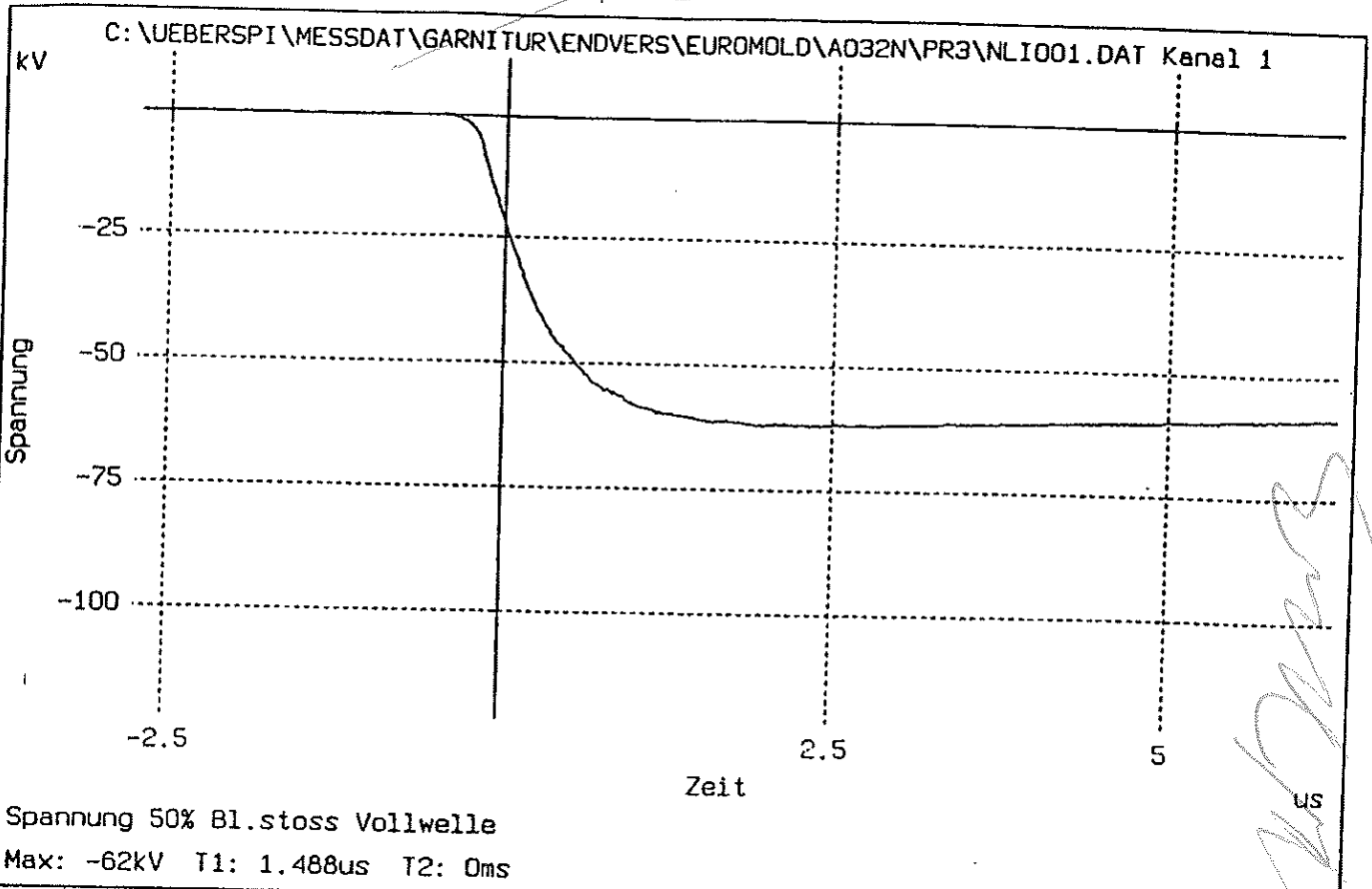

ВЯРНО С
ОРИГИНАЛА

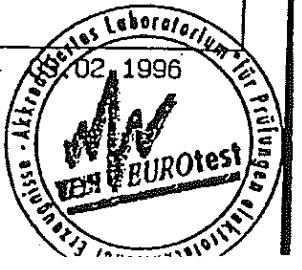
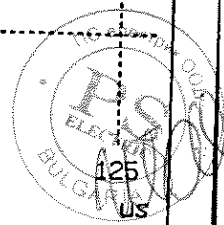

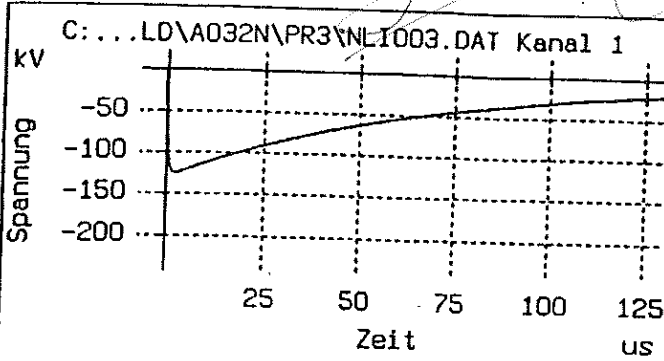

Spannung 100% Bl.stoss Vollwelle
 Max: -124kV T1: 1.457us T2: 51.1u

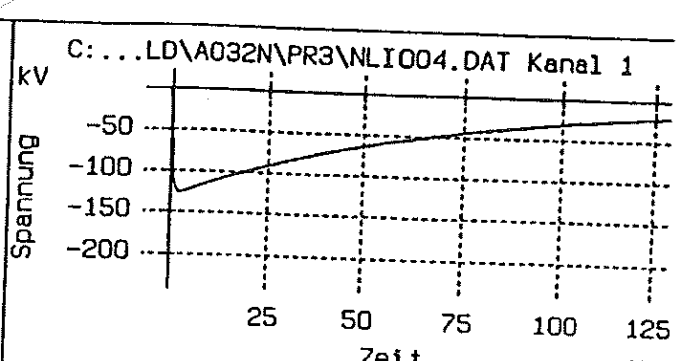

Spannung 100% Bl.stoss Vollwelle
 Max: -125kV T1: 1.461us T2: 50.9u

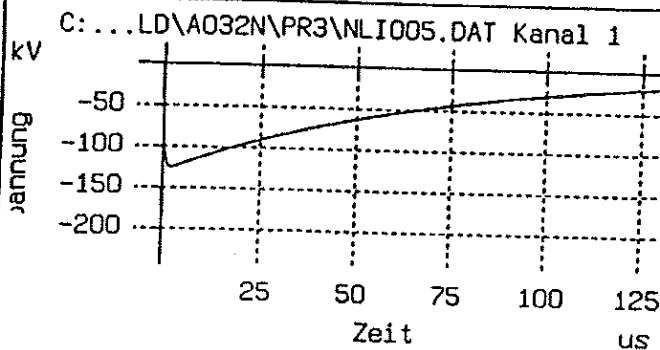

Spannung 100% Bl.stoss Vollwelle
 Max: -125kV T1: 1.494us T2: 51us

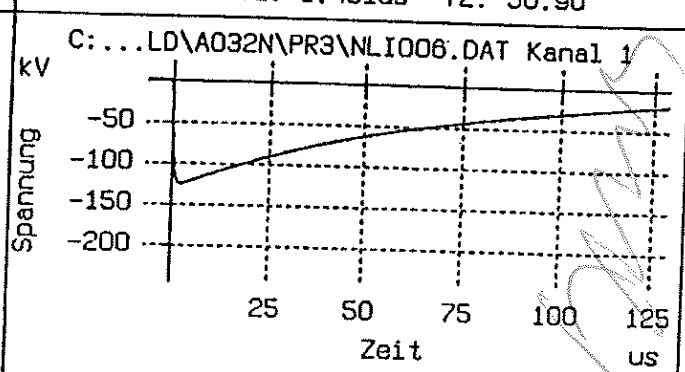

Spannung 100% Bl.stoss Vollwelle
 Max: -125kV T1: 1.492us T2: 50.9u

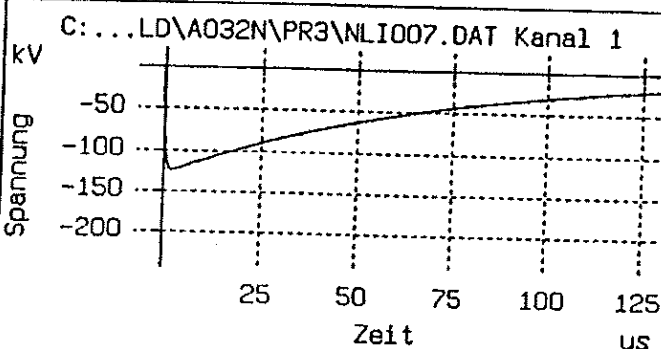

Spannung 100% Bl.stoss Vollwelle
 Max: -125kV T1: 1.463us T2: 51us

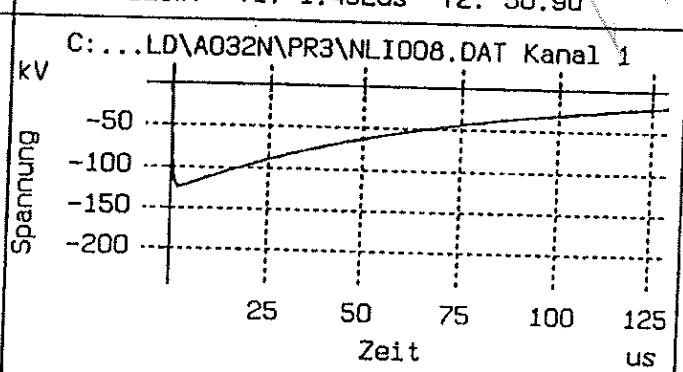

Spannung 100% Bl.stoss Vollwelle
 Max: -125kV T1: 1.498us T2: 51.1u

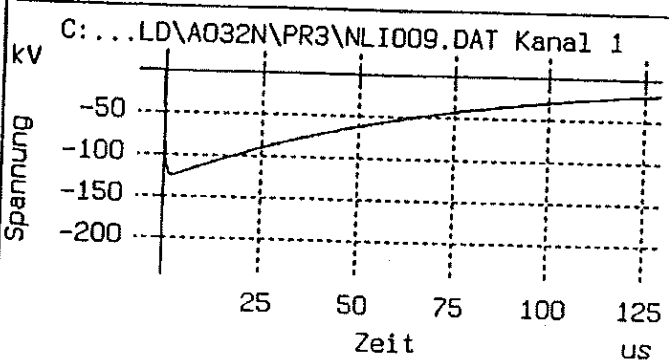

Spannung 100% Bl.stoss Vollwelle
 Max: -125kV T1: 1.458us T2: 51.1u

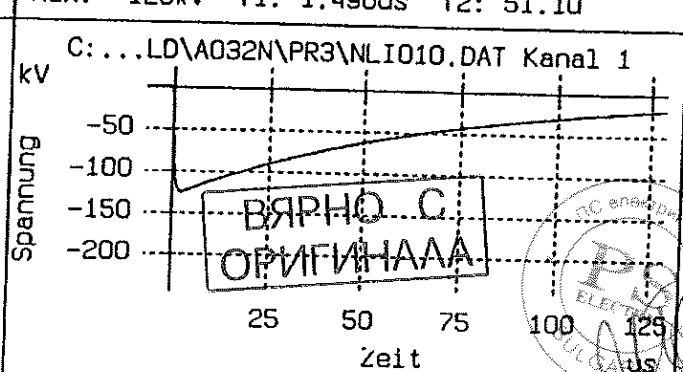

Spannung 100% Bl.stoss Vollwelle
 Max: -125kV T1: 1.485us T2: 51.1u

Prüfling K 158 LR , FabNr.:

Kabelstecker

ВЯРНО С
 ОПРИМНАА

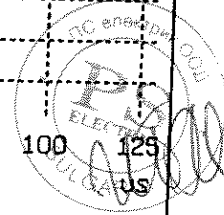

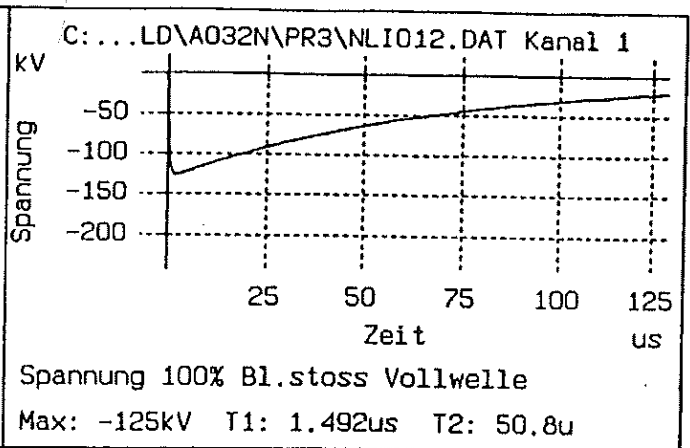
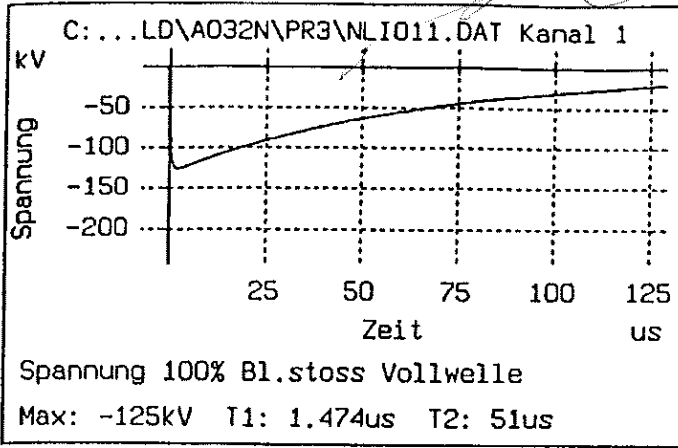

Handwritten signature

ВЯРНО С
ОРИГИНАЛА

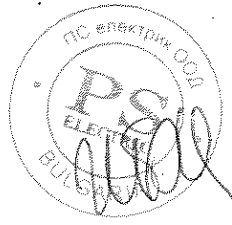

Prüfling K 158 LR , FabNr.:

Kabelstecker

Handwritten signature

[Handwritten signature]

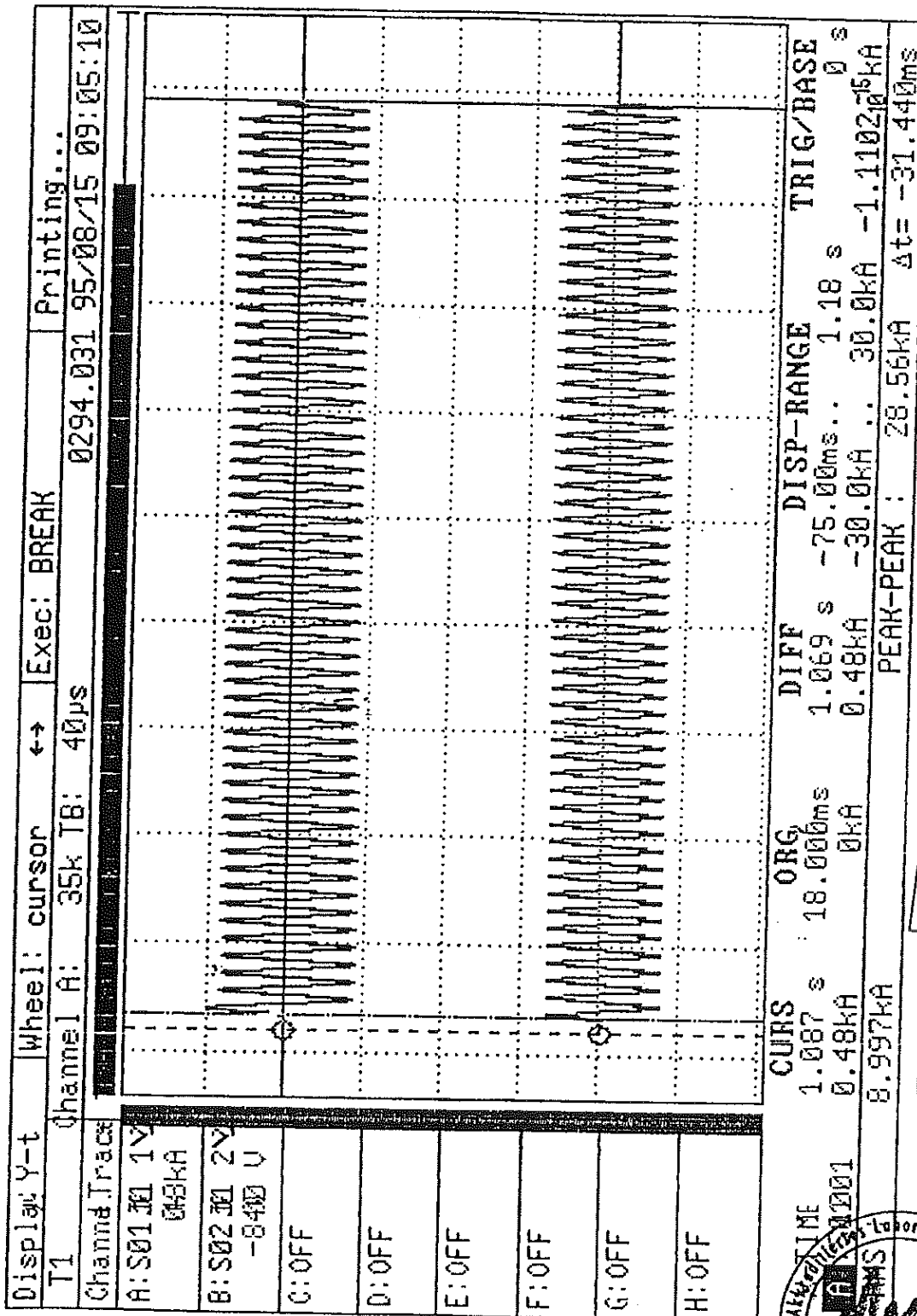

VEN EUROTtest

DATE: 15.8.95

PROF: *[Signature]*

[Handwritten signature]

ВЯРНО С
ОРИГИНАЛА

PC ELECTRONICS

BULGARIA

[Handwritten signature]

Ergebnisse

LABORATORY

BUROtest

Technisches Laboratorium für Richtigungs- und Prüfungen

[Handwritten signature]

Handwritten mark

Display: Y-t	Wheel: cursor	↔	Exec: BREAK	Printing...			
T1	Channel A:	35k TB:	40ps	0294.037 95/08/16 03:56:24			
Channel Trace							
A:S01.001 1V2 0kA							
B:S02.001 2V2 0 U							
C:OFF							
D:OFF							
E:OFF							
F:OFF							
G:OFF							
H:OFF							
CURS		1.097 s	12.800ms	1.085 s	-45.00ms.	1.21 s	TRIG/BASE
X-TIME		0kA	0kA	0kA	-30.0kA	30.0kA	0 s
PEAK-PEAK :		8.888kA		27.84kA			Δt= 29.840ms

VIEW EUROtest
 DATUM: 16.8.95
 PRUFER: *Handwritten signature*

Handwritten signature

ВЯРНО С
ОРИГИНАЛА

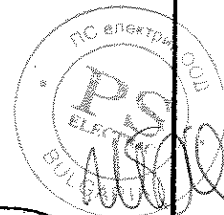

Handwritten signature

[Handwritten signature]

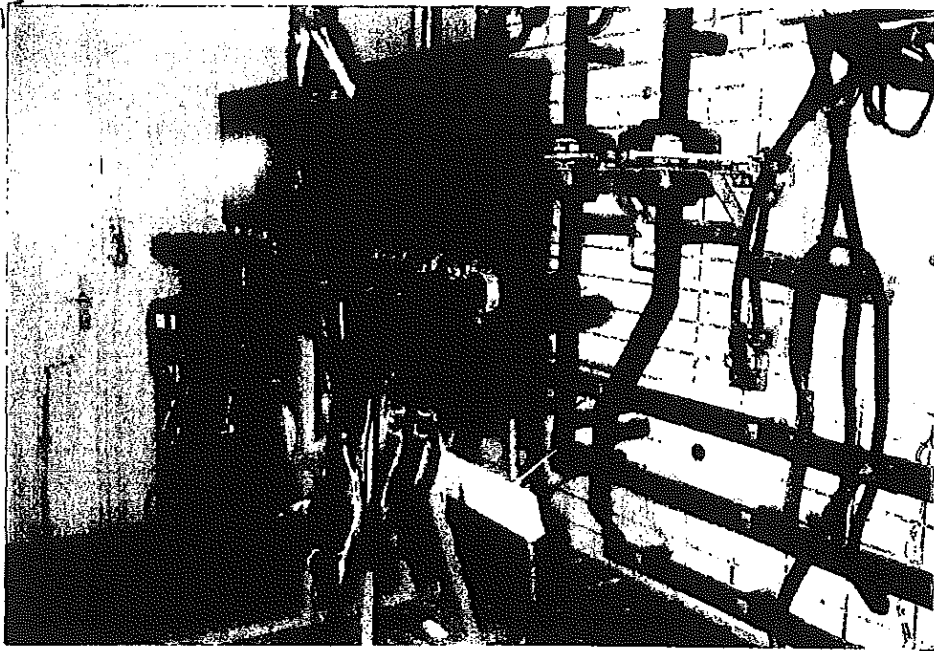

**Bild 1: Prüfaufbau Kurzschlußversuch
Steckerseite**

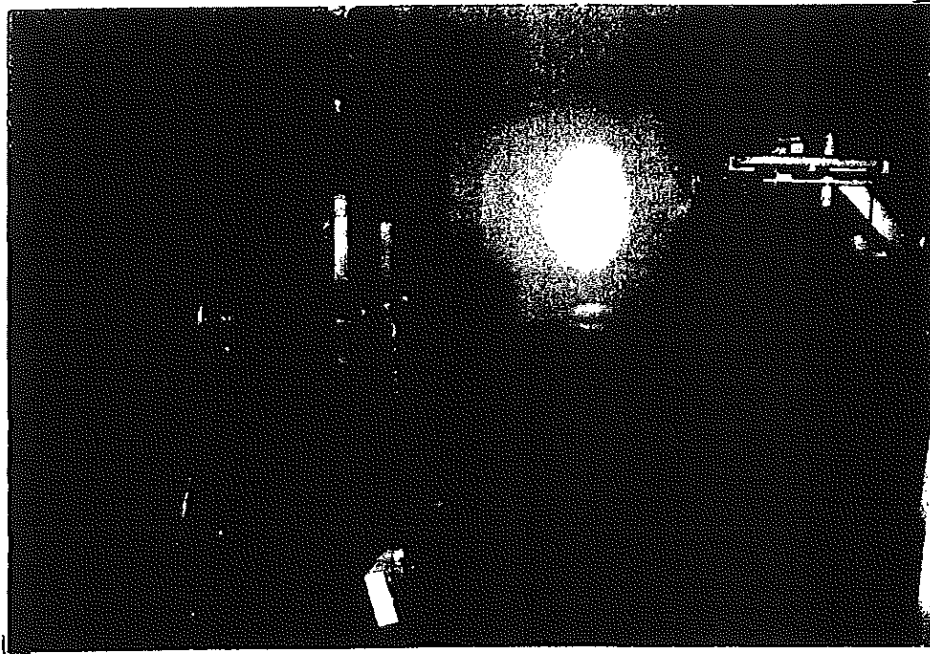

**Bild 2: Prüfaufbau Kurzschlußversuch
Durchführungsseite**

[Handwritten signature]

ВЯРНО С
ОРИГИНАЛА

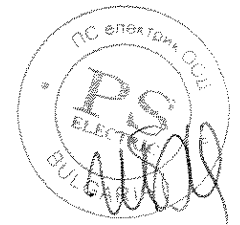

[Handwritten signature]

Handwritten signature

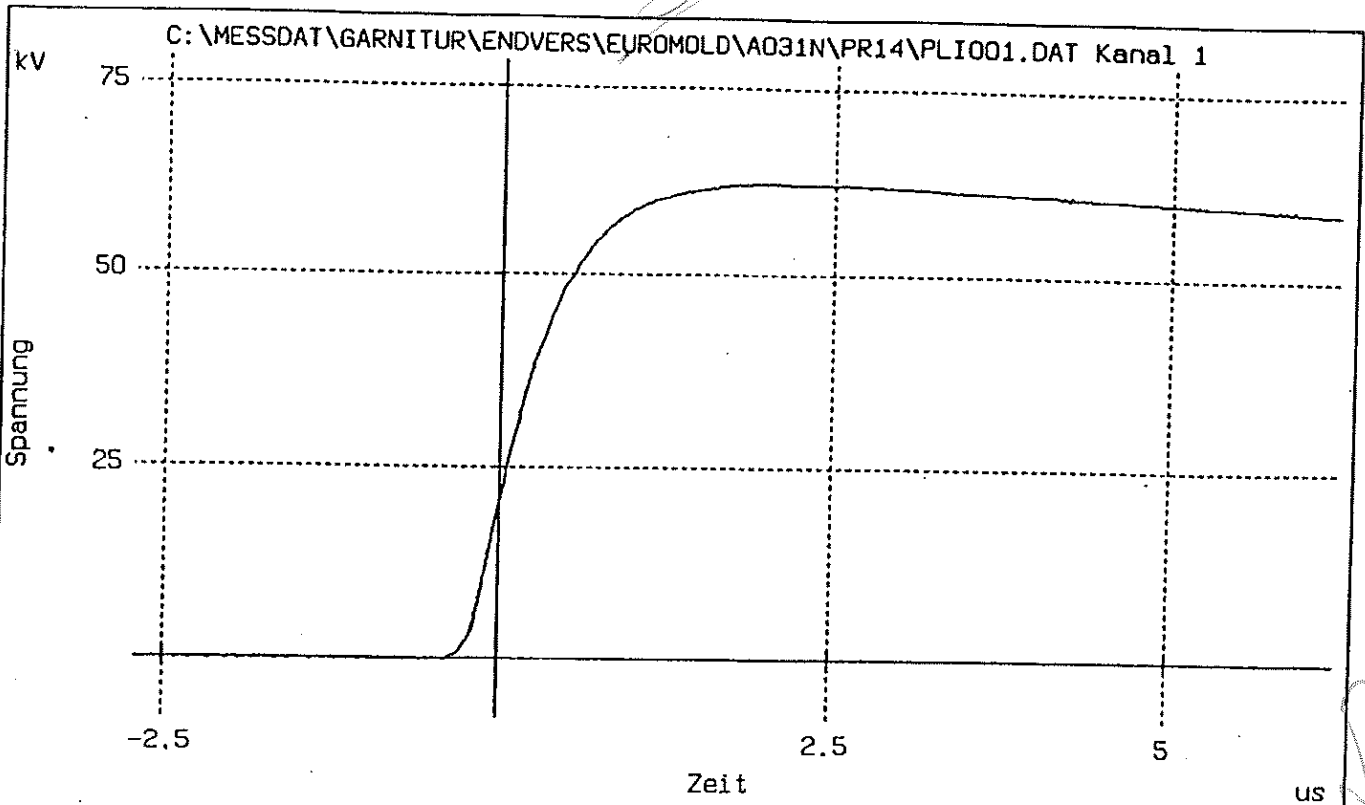

Spannung 50% Bl.stoss Vollwelle
 Max: 62.3kV T1: 1.378us T2: 0ms

Vertical handwritten signature

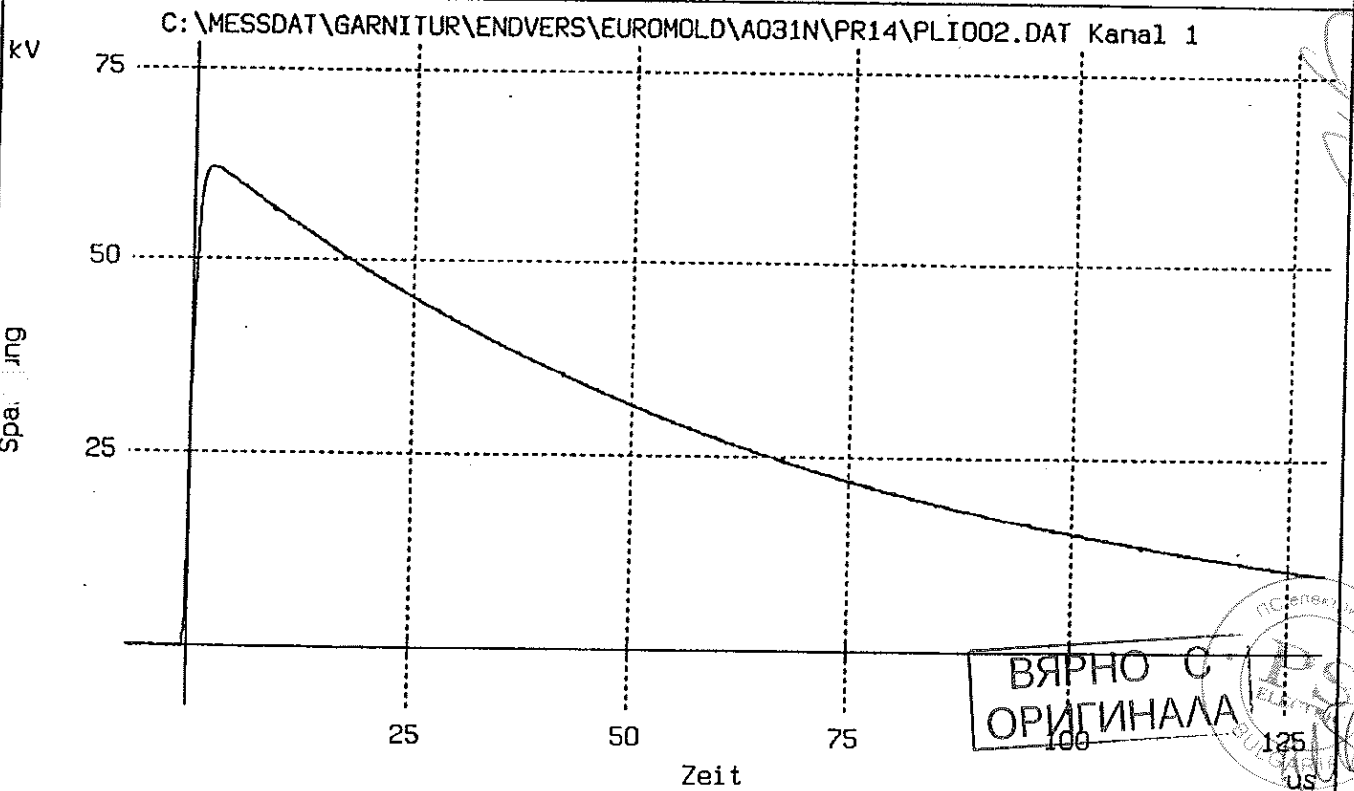

Spannung 50% Bl.stoss Vollwelle
 Max: 62.2kV T1: 1.374us T2: 51.3us

ВЯРНО С
 ОРИГИНАЛА

PC-Systeme
 ELART
 125
 100
 125
 us



Handwritten signature

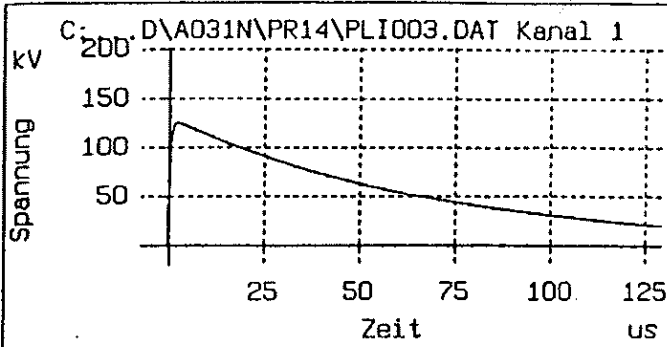

Spannung 100% Bl.stoss Vollwelle
 Max: 125.4kV T1: 1.365us T2: 51.3

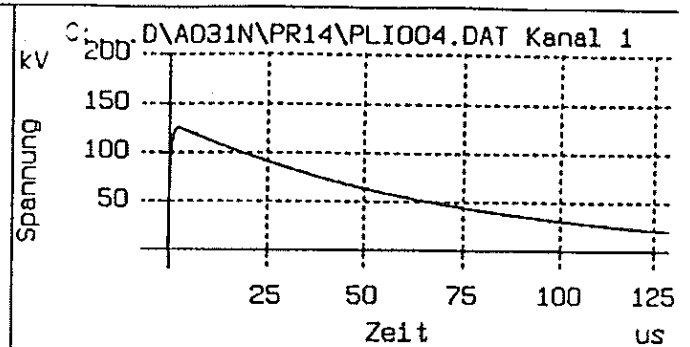

Spannung 100% Bl.stoss Vollwelle
 Max: 125.2kV T1: 1.372us T2: 51.3

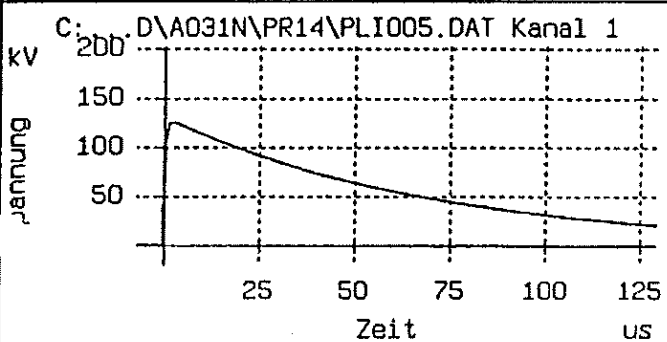

Spannung 100% Bl.stoss Vollwelle
 Max: 125.4kV T1: 1.368us T2: 51.2

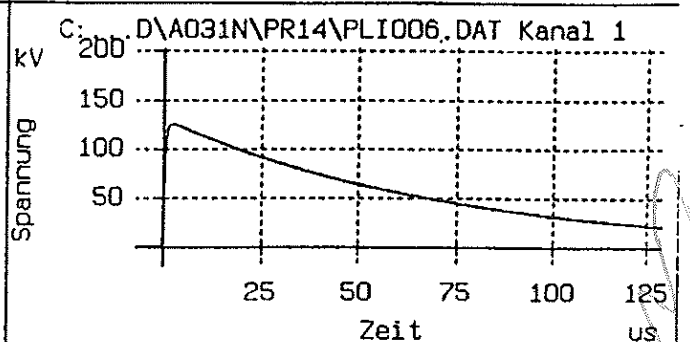

Spannung 100% Bl.stoss Vollwelle
 Max: 125.4kV T1: 1.379us T2: 51.5

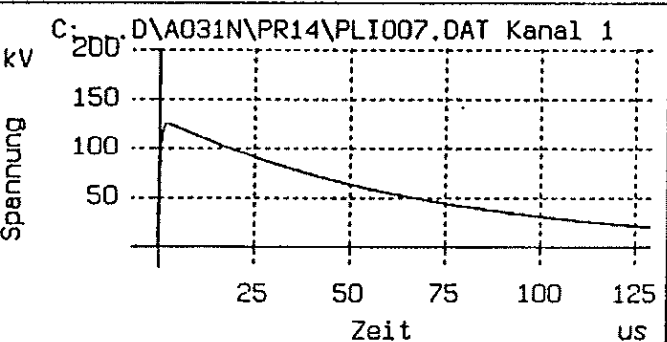

Spannung 100% Bl.stoss Vollwelle
 Max: 125.2kV T1: 1.371us T2: 51.1

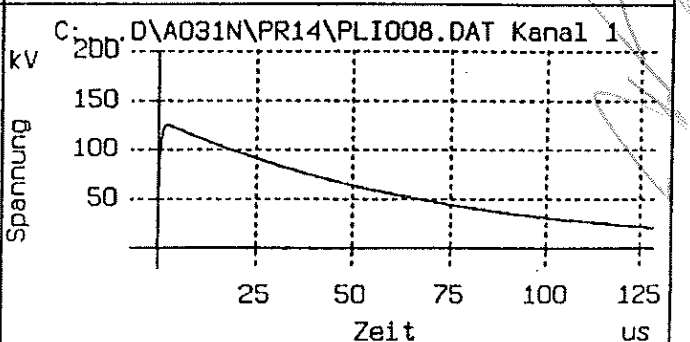

Spannung 100% Bl.stoss Vollwelle
 Max: 125.2kV T1: 1.37us T2: 51.2u

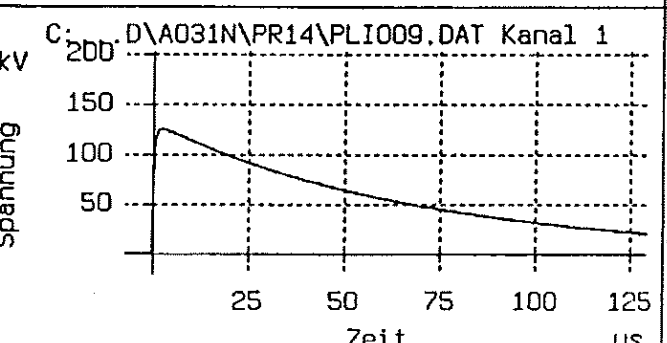

Spannung 100% Bl.stoss Vollwelle
 Max: 125.2kV T1: 1.376us T2: 51.1

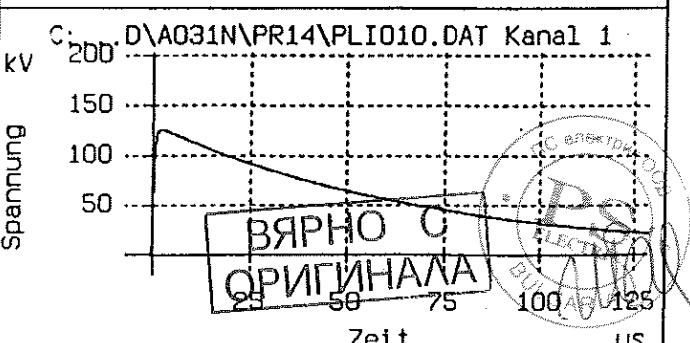

Spannung 100% Bl.stoss Vollwelle
 Max: 125.2kV T1: 1.371us T2: 51.2

Prüfling K 158 LR , FabNr.:

Kabelstecker



ВЯРНО С
 ОПРИГНАЛА

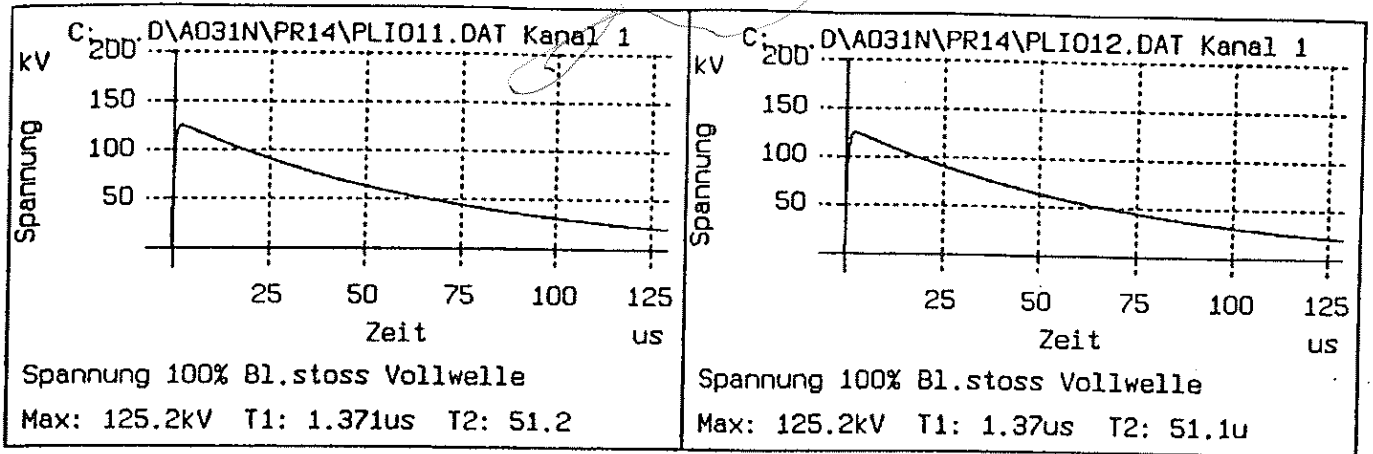

ВЯРНО С
ОРИГИНАЛА

Prüfling K 158 LR , FabNr.:

Kabelstecker

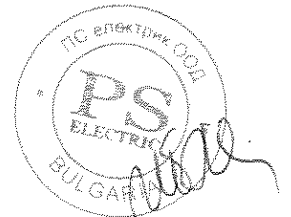

[Handwritten signature]

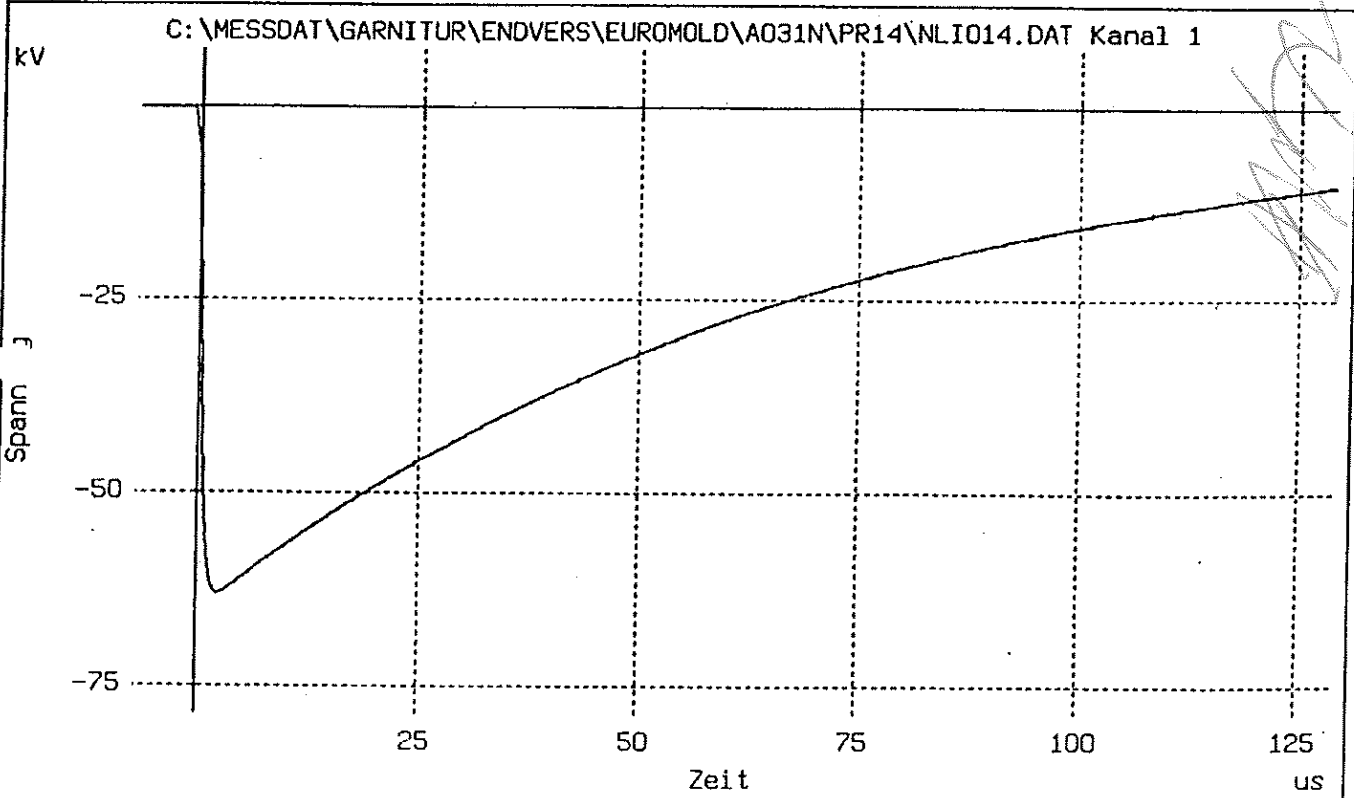
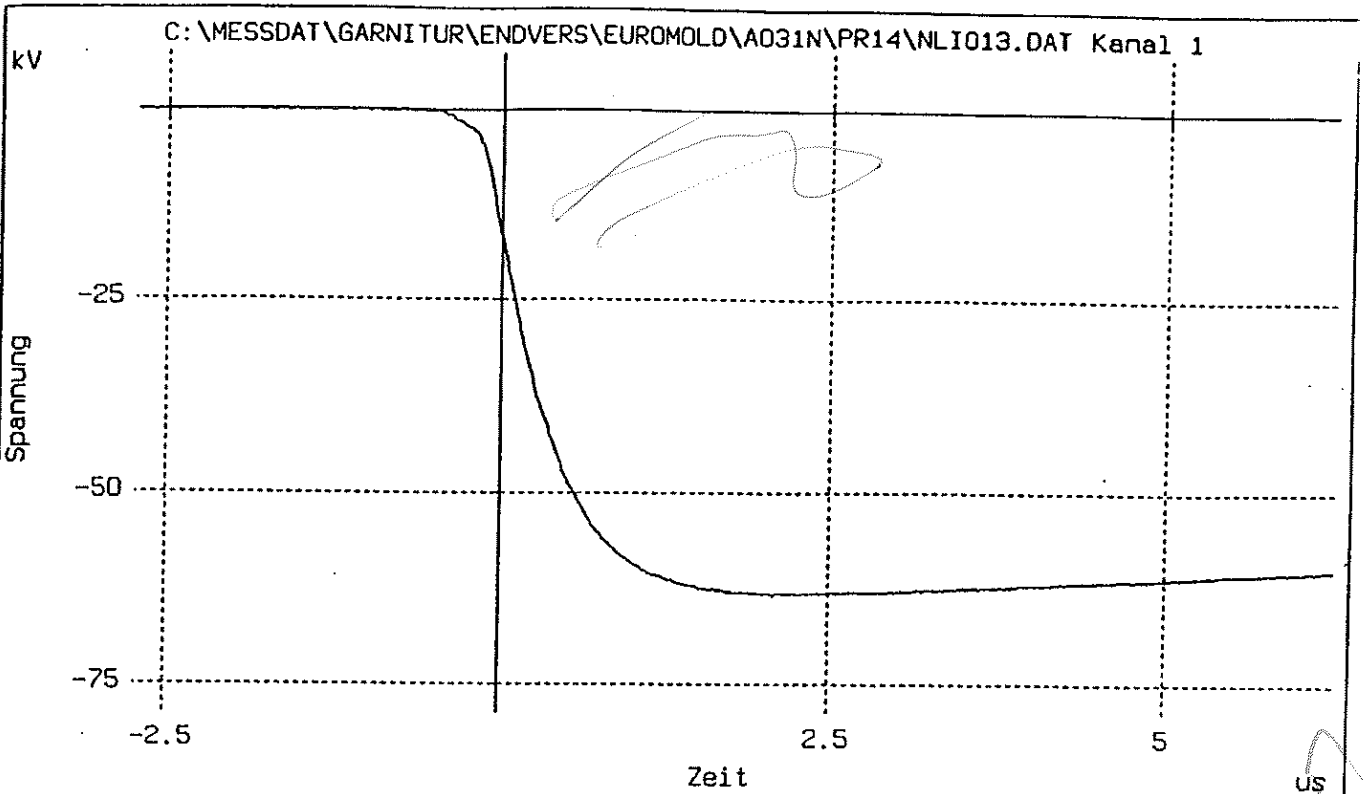

ВЯРНО С
ОРИГИНАЛА

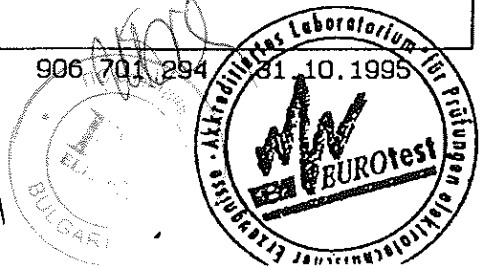

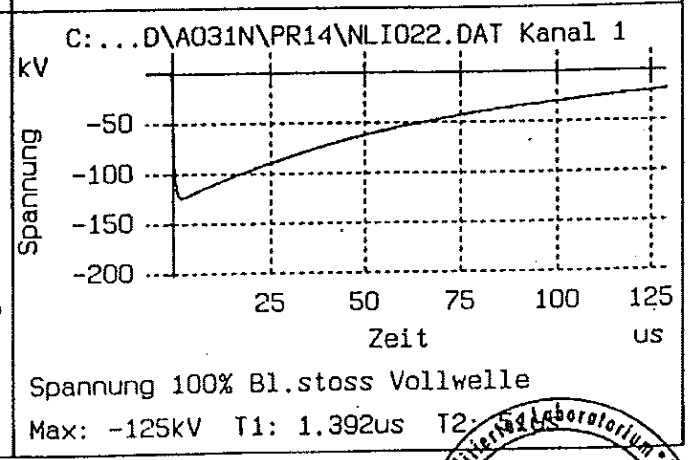
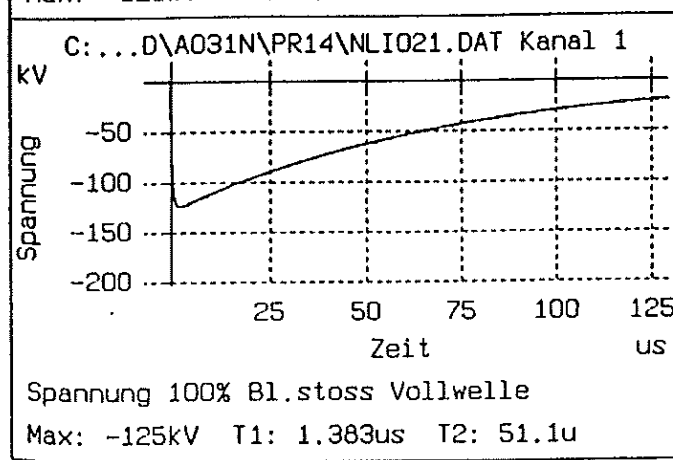
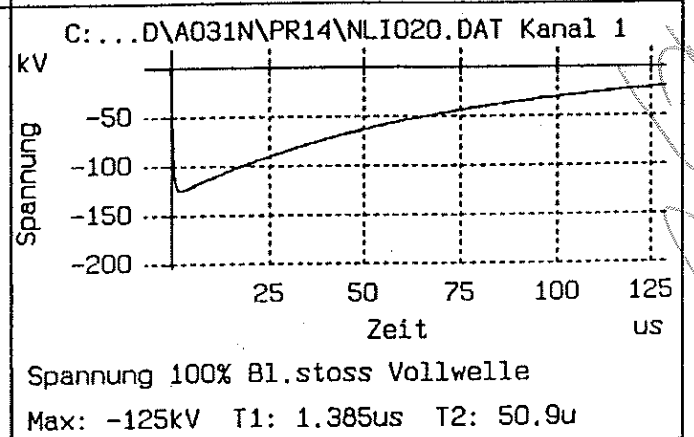
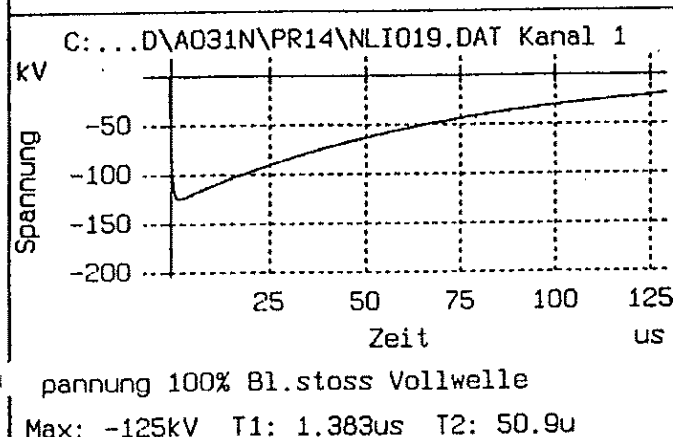
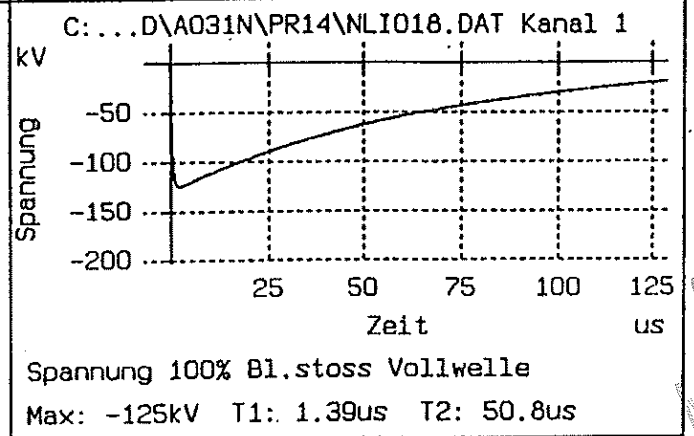
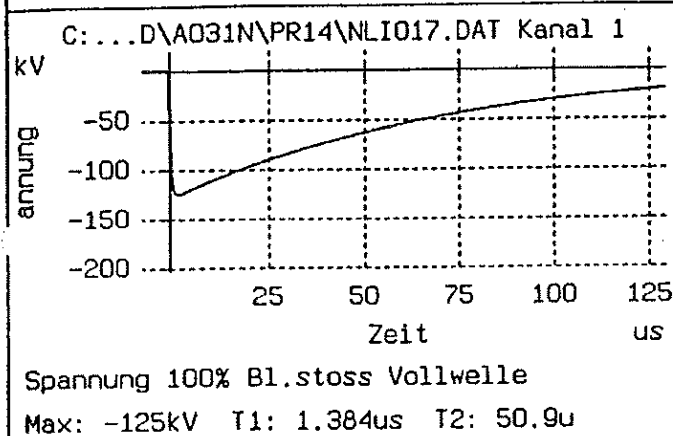
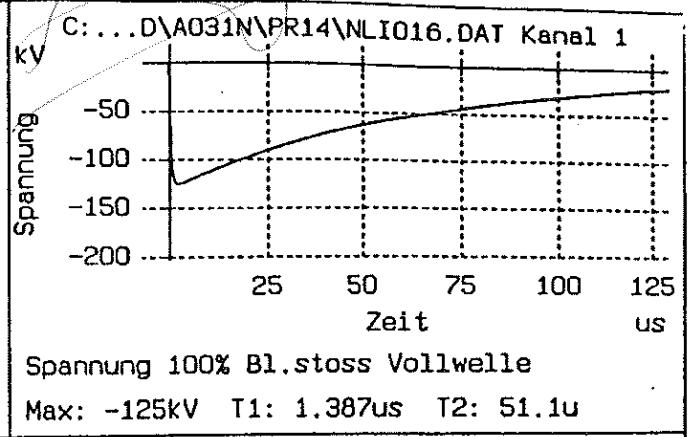
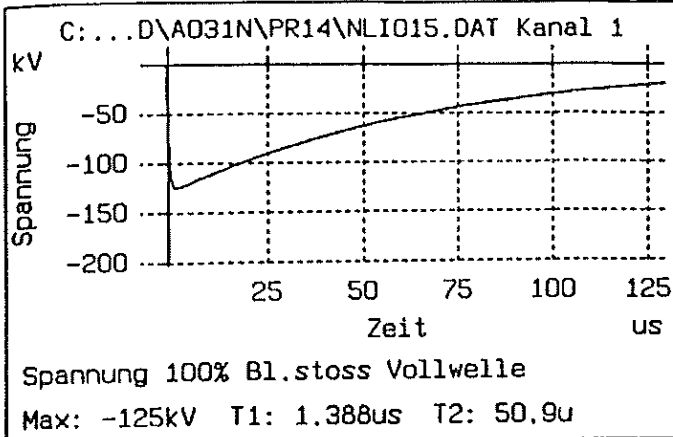

Prüfling K 158 LR , FabNr.:

Kabelstecker

ВРНО С
ОРИГИНАЛ

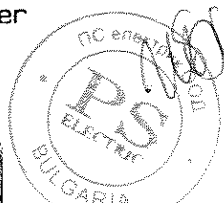

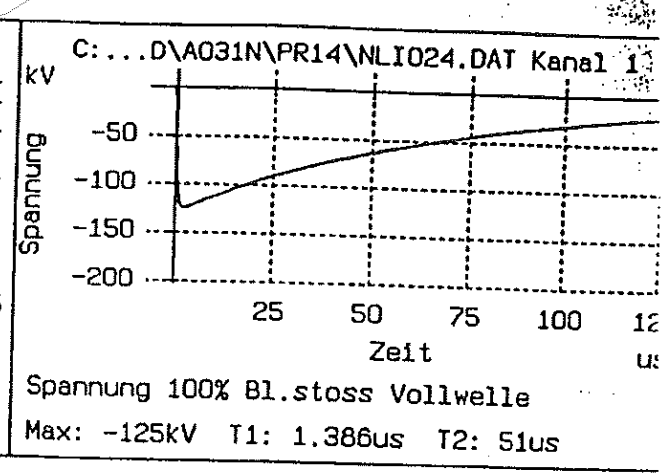
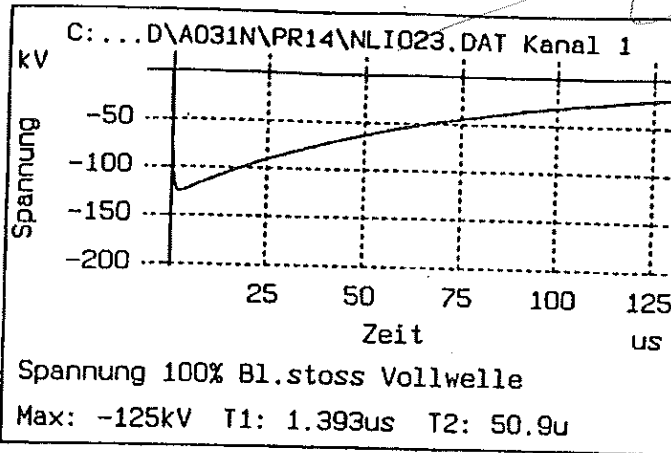

Handwritten signature

**ВЯРНО С
ОРИГИНАЛА**

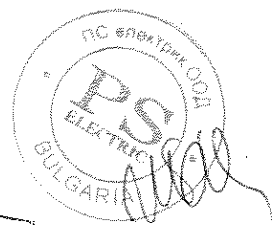

Prüfling K 158 LR , FabNr.:

Kabelstecker



Test equipment

Kalibrierte Prüf- und Meßmittel
AC-Meßsystem, Geräte-No. 429, bestehend aus: AC-Spannungsteiler Übersetzung 8000 : 1, dig. AC-Voltmeter
Teilentladungs-Meßsystem mit kalibriertem TE-Impulsgenerator Geräte-No. 077
Stoßspannungs-Meßsystem Geräte-No. 428 bestehend aus: Stoßspannungsteiler Teilerschaltung 2 Übersetzung 557,5 : 1, Stoßspannungs-Voltmeter, digitales Meß- und Auswertesystem
AC-Spannungsteiler Übersetzung 2000: 1 kalibriert mit Übersetzungsmeßgerät Geräte-No. 325 mit Digitalmultimeter Geräte-No. 073 Zangenstromwandler Geräte-No. 439/441 Digitalmultimeter Geräte-No. 074/075
Stromwandler Geräte-No. 9, 10, 11 Meßumformer Geräte-No. 228, 229, 230, 233 Hochstrom-Meßwiderstände Geräte-No. 237, 238, 239
DC-Meßsystem Geräte-No. 399 bestehend aus: DC-Spannungsteiler u. digit. DC-Voltmeter
Digitalmultimeter Geräte-No. 71, 396
Hochstrom-Meßwiderstände Geräte No. 1250, 1282, 10-kV-I-Wandler ü = 5 A : 1 A, 10-kV-I-Wandler Ü = 10000 V : 100 V



**ВЯРНО С
ОРИГИНАЛА**

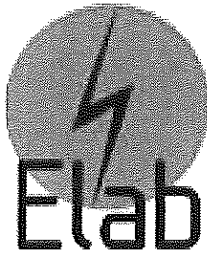

ELECTRICAL TESTING LABORATORY

EUROMOLD N.V., ZUID III, Industrielaan 12
B-9320 EREMBODEGEM (AALST)

3KASON

TEST REPORT

Nr. **TE 213 04 03**: contains 9 pages and 7 appendices

Requestor: EUROMOLD N.V.
ZUID III
Industrielaan 12
B-9320 EREMBODEGEM

TEST OBJECT TYPE : Separable Tee-connector – Interface type C (EN 50180)
: **430TB-630A**
Rated voltage U_c/U : 12.7/22 kV
Highest system voltage U_m : 24 kV
Rated current : 630A
Manufacturer : EUROMOLD N.V.
Request number : TRF 2003-44

Start and end date
03/03/04 – 06/05/04
24/02/04 – 12/03/04

Test specification
CENELEC HD 629.1 S1 (11/1996) + A1 (2001)
Test requirements
CENELEC HD 628 S1 (11/1996) + A1 (2001)
Test methods
**Test series : Table 7, sequences D1
and D2 + additional tests Nos. 19 to 21
and 23**

TEST RESULT: the test object successfully passed the prescribed test series.

На основание чл. 2
от ЗЗЛД

Erembodegem, 02 December 2004

Made in 4 copies
Copy nr 4

ВЯРНО С
ОРИГИНАЛА

ELAB
TEST
Nr 192-F

This report may not be reproduced in part, unless authorized so formally by the laboratory. The report applies to the tested objects only.

Test request TE 213 04 03

Page 1 of 9





Résumé

A type test in accordance with HD 629.1 S1 (11/1996) + A1 (2001) was performed on separable tee-connectors, with type designation 430TB-630A, manufactured by EUROMOLD N.V.

These are intended for application on networks 12.7/22 (24) kV on single-core cables with extruded insulation.

Purpose of the test is to qualify the 430TB-630A for use on systems 12.7/22 (24) kV.

The separable tee-connector **430TB-630A** passed the tests at level **12.7/22 (24) kV**, according to HD 629.1 S1 (11/1996) + A1 (2001) table 7 sequence D1 as shown in this report.

Subcontracting.

The separable tee-connector **430TB-630A** passed the tests at level **12.7/22 (24) kV**, according to HD629.1 S1 (11/1996) + A1 (2001) table 7 sequence D2 as well as special tests Nos. 19 to 21 and 23, as shown in the test report No. 1569.0204.4.53 from IPH-Berlin (cfr. references).

Deviations and exceptions.

The test level of the partial discharge tests, clause 7 of HD 628 S1 was elevated from $1.73 U_0$ to $2U_0$.

ВЯРНО С
ОРИГИНАЛА

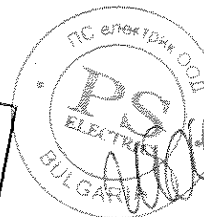



Contents

Résumé	2
1 Test specifications	4
2 Technical data and identification of the test objects	5
3 Test cable arrangement.....	6
4 Test procedures, requirements and test results.....	7
4.1 TYPE TEST TABLE 7, SEQUENCE D1	7
5 References.....	8
5.1 EXTERNAL TEST REPORTS.....	8
6 Appendices.....	9

ВЯРНО С
ОРИГИНАЛА

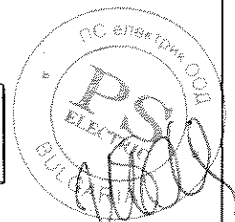



1 Test specifications

CENELEC HD 628 S1 (11/1996) + A1 (2001) English version

Test methods for accessories for power cables with rated voltages from 3.6/6 kV ($U_m=7.2$ kV) up to and including 20.8/36 kV ($U_m=42$ kV).

CENELEC HD 629.1 S1 (11/1996) + A1 (2001) English version

Test requirements on accessories for use on power cables with rated voltages from 3.6/6 kV ($U_m=7.2$ kV) up to and including 20.8/36 kV ($U_m=42$ kV).

Part 1: Cables with extruded insulation.

All measuring equipment used in the test series is calibrated, traceable to international standards.

The relevant measurement uncertainty has been determined according to EA - 4/02 'Expression of the Uncertainty of Measurement in Calibration' (Dec. 1999) and judged satisfactory by SOCOTEC Industries S.A. Seclin, France.

ВЯРНО С
ОРИГИНАЛА





2 Technical data and identification of the test objects

Technical data:

Test object : Separable tee-connector – interface type C

Designation : 430TB-630A

Assembly instruction : IS 430TB-630A-E-45 (06/2004) 90722E-R/1

Rated current : 630A

Rated voltage U_0/U : 12.7/22 kV

U_m : 24 kV

Identification of the test objects:

Test sequence D1:

Receiving date : week 10 (02/03/2004)

Number of test objects : 4

Identification numbers : 02032004-01

02032004-02

02032004-03

02032004-04

Cable : 185 mm² - Cu – 12/20 (24) kV

Manufacturer : FACAB

Marking : FACAB 60102 N2XS_Y 1x185/25 20kV VDE 2002

More technical data in appendix 2

ВЯРНО С
ОРИГИНАЛА



3 Test cable arrangement

- For test series **table 7, sequence D1** the separable tee-connectors were mounted on 2 separate loops with each test object resp. identified with the nos. 02032004-01, -02, -03, -04.
Each end of the loops was equipped with a termination of the type 36MT and each tee-connector installed on a transformer bushing of the type (M) 400AR-3.

The cable had approx. 3m of length
(technical data of the cable in appendix 2, "Identification of the test cable").

The cable loops were assembled on 02/03/2004 at Euromold, Erembodegem.
The tests started on 03/03/2004 not earlier than 24 hours after the installation of the accessories on the cable.

All test voltages were applied to the core against the cable screen, which was connected to the test earth.

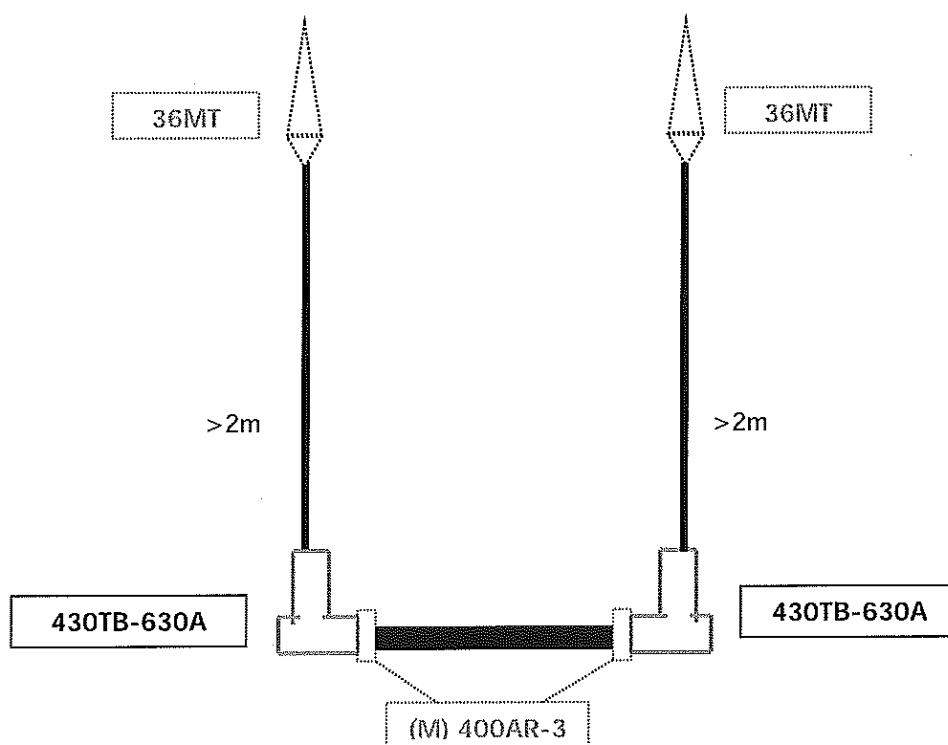



4 Test procedures, requirements and test results

4.1 Type test table 7, sequence D1.

The test procedures and requirements according to HD 629.1 S1 (11/1996) + A1 (2001), table 7 sequence D1 and the test results are summarized in appendix 1.

All test objects successfully passed the prescribed tests.

ВЯРНО С
ОРИГИНАЛА

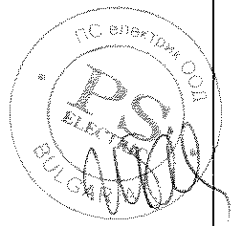



5 References

5.1 External test reports

Test specification	Laboratory	Report number	Report date	Result
HD 629.1 S1: 1996 + A1: 2001 Table 7, Test series D2 level 12.7/22 (24) kV and tests nos. 19 to 21 and 23	IPH - Institut "Prüffeld für Elektrische Hochleistungstechnik" GmbH	1569.0204.4.053	18/11/2004	Passed

ВЯРНО С
ОРИГИНАЛА

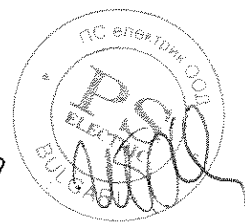

[Handwritten signature]



6 Appendices

Appendix	Reference:	Title	Pages
1	LAB-QREG-C17	Type test on cable accessories per HD 629.1 S1, table 7, sequence D1.	2
2	LAB-QREG-D1-1	Identification of the test cable.	1
3	Appendix 3	Extract of registration of current, voltage and temperature during the heat cycle test.	4
4	Appendix 4	Extract of registration of lightning impulse wave shape.	1
5	Appendix 5	Test arrangement (pictures) sequence D1.	1
6	LAB-QREG-012-01	List of equipment used.	2
7	IS 430TB-630A-E-45 (06/2004) 90722E-R/1	Installation instruction. 430TB-630A	9

[Handwritten signature]

**ВЯРНО С
ОРИГИНАЛА**

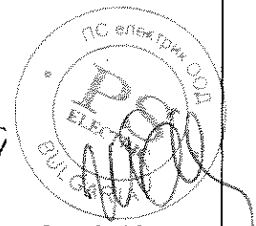

[Handwritten signature]

TYPE TEST ON CABLE ACCESSORIES PER HD 629.1 S1, TABLE 7, SEQUENCE D1.



LAB-QREG-C17 Rev.C	Type test on screened separable connectors, 630 A for systems 12.7/22 (24) kV per HD629.1 S1, series D1 - Table 7	
TRF N° 2003-44	Project N° C0401	Test report N° 21304-03

	Test title	Procedure	Requirement	Result	Initials	Date
	Assembly				JOC	02/03/2004
1	DC withstand voltage test (HD628 § 5)	Apply continuous voltage of 76 kV, for a duration of 15 minutes	No breakdown or flashover shall occur.	OK	JOC	03/03/2004
2	AC withstand voltage test, dry (HD628 § 4.1)	Apply alternating voltage of 57 kV, for a duration of 5 minutes	No breakdown or flashover shall occur.	OK	JOC	03/03/2004
3	PD test at ambient temperature (HD628 § 7.1)	Raise the voltage to 31,9kV and hold for less than 1 minute. Lower the voltage to 25,5 kV, and measure the PD magnitude.	PD level to be less than 10pC.	OK	JOC	03/03/2004
4	Impulse withstand voltage test at elevated temperature (HD628 § 6)	Stabilise the conductor temperature between 95°C and 100°C. Apply 10 positive and 10 negative impulses (1.2/50µsec) of 125 kV.	No breakdown or flashover shall occur.	OK	JOC	04/03/2004
5	Electrical heat cycling in air (HD628 § 9)	Apply 3 thermal cycles in air of minimum 8 hours, with at least 2 hours at a conductor temperature between 95°C and 100°C, at a alternating voltage of 32 kV	No breakdown or flashover shall occur.	OK	JOC	Start 05/03/2004 Stop 08/03/2004
6	PD test at elevated temperature (HD628 § 7)	Stabilise the conductor temperature between 95°C and 100°C. Raise the voltage to 31,9kV and hold for less than 1 minute. Lower the voltage to 25,5 kV, and measure the PD magnitude.	PD level to be less than 10pC.	Ok	JOC	08/03/2004
7	PD test at ambient temperature (HD628 § 7.1)	Raise the voltage to 31,9kV and hold for less than 1 minute. Lower the voltage to 25,5 kV, and measure the PD magnitude.	PD level to be less than 10pC.	OK	JOC	09/03/2004

**ВЯРНО С
ОРИГИНАЛА**

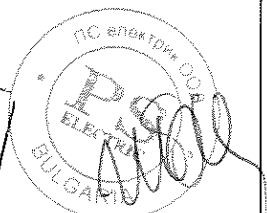

TYPE TEST ON CABLE ACCESSORIES PER HD 629.1 S1, TABLE 7, SEQUENCE D1.



	<u>Test title</u>	<u>Procedure</u>	<u>Requirement</u>	<u>Result</u>	<u>Initials</u>	<u>Date</u>
8	Electrical heat cycling in air (HD628 § 9)	Apply 60 thermal cycles in air of minimum 8 hours, with at least 2 hours at a conductor temperature between 95°C and 100°C, at a alternating voltage of 32 kV.	No breakdown or flashover shall occur.	OK	JOC	Start 09/03/2004 Stop 29/03/2004
9	Electrical heat cycling in water (HD628 § 9)	Apply 63 thermal cycles - submersed in water - of minimum 8 hours, with at least 2 hours at a conductor temperature between 95°C and 100°C, at a alternating voltage of 32 kV.	No breakdown or flashover shall occur.	OK	JOC	Start 02/04/2004 Stop 23/04/2004
10	Disconnect/reconnect	Disconnect/reconnect 5 times.	Disconnect/reconnect	OK	JOC	03-04 /05/2004
11	PD test at elevated temperature (HD628 § 7)	Stabilise the conductor temperature between 95°C and 100°C. Raise the voltage to 31,9kV and hold for less than 1 minute. Lower the voltage to 25,5 kV, and measure the PD magnitude.	PD level to be less than 10pC.	OK	JOC	05/05/2004
12	PD test at ambient temperature (HD628 § 7.1)	Raise the voltage to 31,9kV and hold for less than 1 minute. Lower the voltage to 25,5 kV, and measure the PD magnitude.	PD level to be less than 10pC.	OK	JOC	05/05/2004
13	Impulse withstand voltage test at ambient temperature (HD628 § 6)	Apply 10 positive and 10 negative impulses (1.2/50µsec) of 125 kV to the test object.	No breakdown or flashover shall occur.	OK	JOC	06/05/2004
14	AC withstand voltage test, dry (HD628 § 4.1)	Apply alternating voltage of 32 kV, for a duration of 15 minutes	No breakdown or flashover shall occur.	OK	JOC	06/05/2004
15	Examination		For information only			06/05/2004

ВЯРНО С
ОРИГИНАЛА

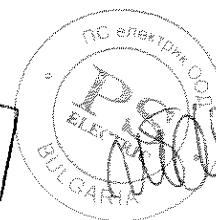

IDENTIFICATION OF THE TEST CABLE



LAB-QREG-D1-1 Rev: 04/2003	Identification of test cable / Identificatie van de testkabel		
Rated voltage(U _o /U (U _m):	12/20kV (24) kV		
Construction	<input checked="" type="checkbox"/>	1-core / 1-aderig	3-core / 3-aderig
	<input checked="" type="checkbox"/>	Individually screened / individueel scherm	Not individually screened / niet individueel afgeschermd
Conductors / geleiders		Aluminium	<input checked="" type="checkbox"/> Copper / Koper
	<input checked="" type="checkbox"/>	Stranded / meerdradig	Solid / massief
	<input checked="" type="checkbox"/>	Round / rond	Shaped / sectoraal
		120 mm ²	
		150 mm ²	
	<input checked="" type="checkbox"/>	185 mm ²	
	Other cross-section / andere sectie	mm ²
Insulation / isolatie		PVC	HEPR
	<input checked="" type="checkbox"/>	XLPE	EPR
Insulation screen / isolatiescherm	<input checked="" type="checkbox"/>	Bonded / afschilbaar	Strippable / afpelbaar
Metallic screen / metalen scherm	<input checked="" type="checkbox"/>	Wire / draad	<input checked="" type="checkbox"/> Copper / koper
		Tape / band	Aluminium
		Extruded / ge-extrudeerd	Lead / lood
		Individual / individueel	Common / gemeenschappelijk
Oversheath / buitenmantel		PVC	
	<input checked="" type="checkbox"/>	PE	
Waterblocking / water barriere		In conductor / in de geleider	Under oversheath / onder de mantel
Diameters	16.63	Conductor / geleider	
	17.5	Conductor shield / geleiderscherm	
	28.26	Insulation / isolatie	
	29.47	Insulation shield / isolatiescherm	
	37.17	Oversheath / mantel	
Marking /	Facab 60102 N2XSY 1x185/25 20kV <VDE> 2002		
Manufacturer / fabrikant	FACAB		
Delivery reference / Levering	2003		
Project:	Project = C0401		
Test report/ - request.	TE 213 04 03	2003-44	
Measured by / gemeten door	Johan Cauwel	Date:	09/06/2004
Thermal calibration versus jacket	A: 50.348E ⁻⁶	B: 113.853E ⁻⁹	
Thermal calibration versus ambient	A': 123.1784E ⁻⁶	B': 184.4896E ⁻⁹	

**ВЯРНО С
ОРИГИНАЛА**

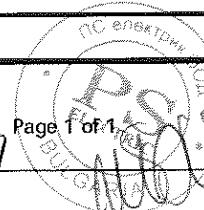

EXTRACT OF REGISTRATION OF CURRENT, VOLTAGE AND TEMPERATURE DURING THE HEAT CYCLE TEST



Electrical heat cycling in air (test n° 8):
Registration on 09/03 & 10/03/2004

Model: 20040303
 Date: 09/03/2004
 File name: 20040303_09_03_03_03_03
 Start time: 10:00:00
 Stop time: 10:00:00
 Target time: 10:00:00
 Target ID: 1
 Sample rate: 1000

File name: 20040303_09_03_03_03_03
 Device: 20040303_09_03_03_03_03
 Serial No: 20040303_09_03_03_03_03
 File: 20040303_09_03_03_03_03
 Time: 20040303_09_03_03_03_03
 Starting condition: 20040303_09_03_03_03_03
 Ending condition: 20040303_09_03_03_03_03
 User ID: 1

Voltage range: 0-100kV
 Voltage range: 0-100kV
 Current range: 0-1000A
 Current range: 0-1000A

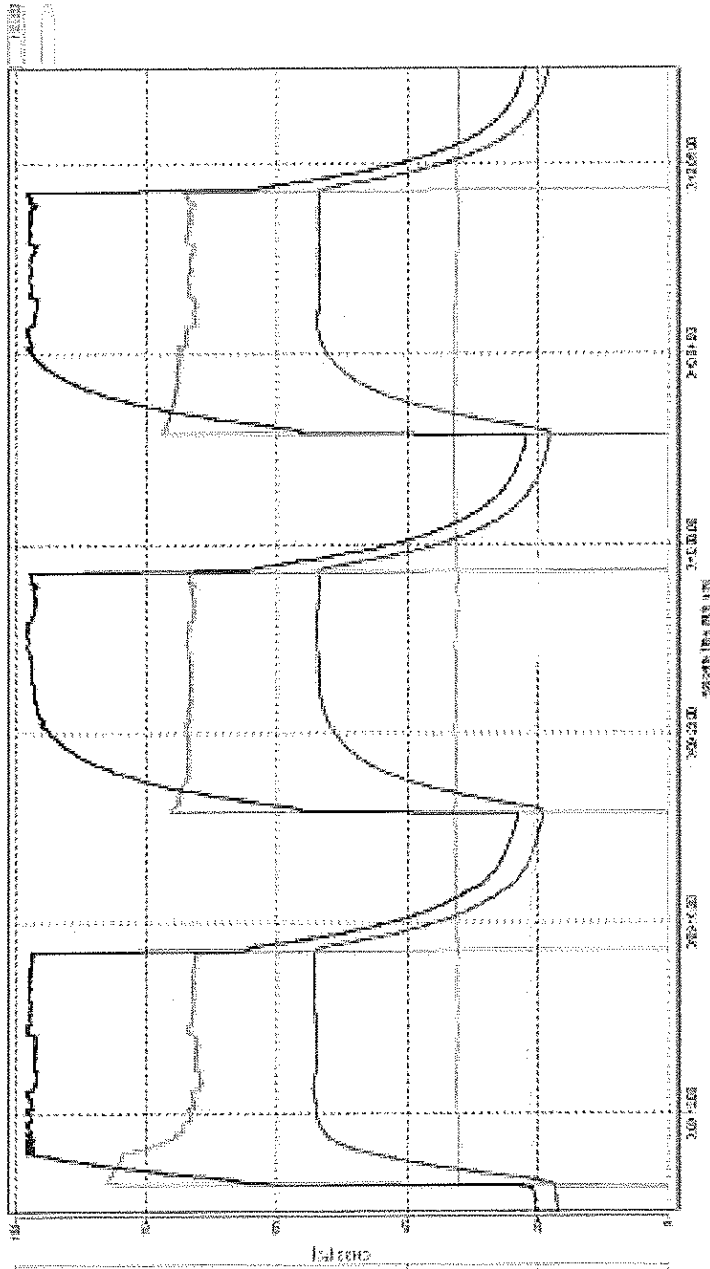

- Current (0-1000A)
- Calculated conductor temperature (0-100°C)
- Voltage (0-100kV)
- Cable jacket temperature (0-100°C)

ВЪРНО С
 КОПИЕ

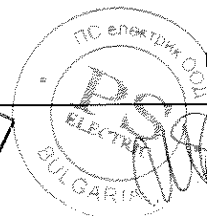

EXTRACT OF REGISTRATION OF CURRENT, VOLTAGE AND TEMPERATURE DURING THE HEAT CYCLE TEST



Registration on 28/03 & 29/03/2004

Order No. 2004032801
 Order Date 28/03/2004
 Order Time 11:20:00
 Order Ref. 2004032801
 Project No. 2004032801
 Damage Check 17/03/04
 Post Damaged

Order No. 2004032901
 Order Date 29/03/2004
 Order Time 11:20:00
 Order Ref. 2004032901
 Project No. 2004032901
 Damage Check 17/03/04
 Post Damaged

Order No. 2004032901
 Order Date 29/03/2004
 Order Time 11:20:00
 Order Ref. 2004032901
 Project No. 2004032901
 Damage Check 17/03/04
 Post Damaged

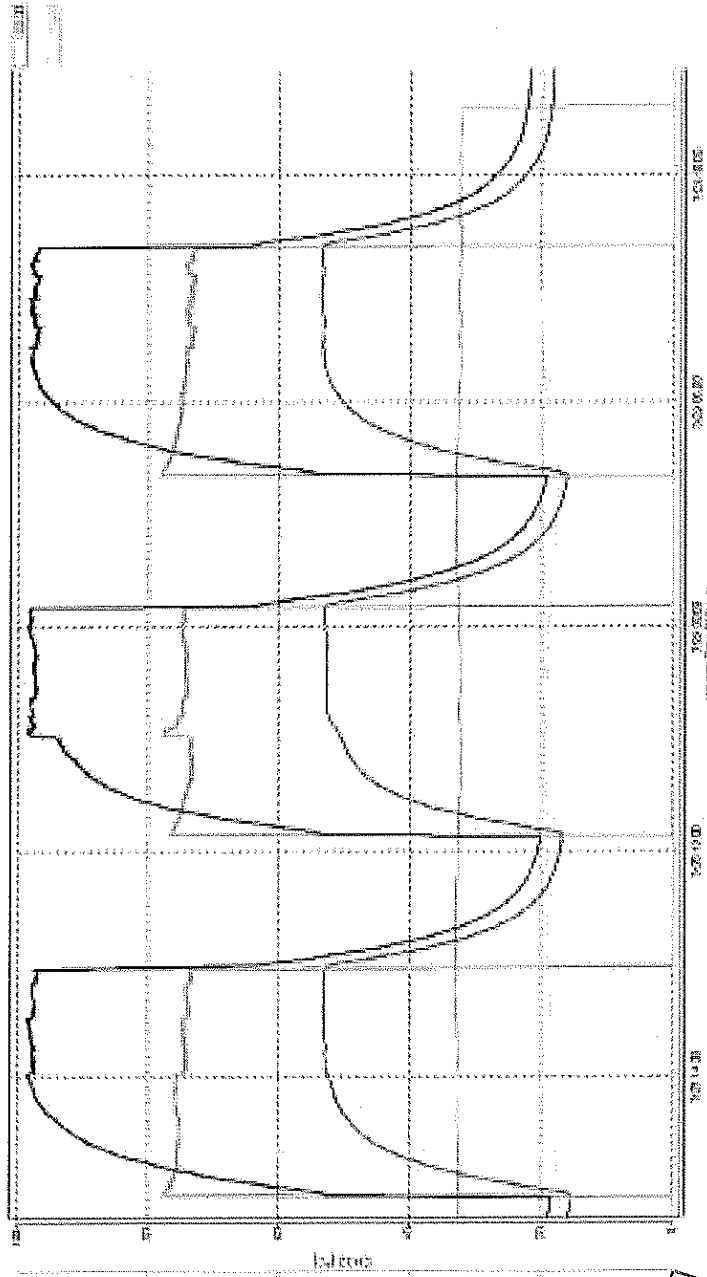

Current (0-1000A)
Voltage (0-100kV)

Calculated conductor temperature (0-100°C)
Cable jacket temperature (0-100°C)

**ВЯРНО С
ОРИГИНАЛА!**

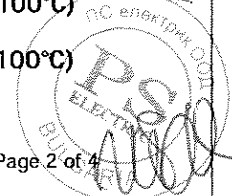

EXTRACT OF REGISTRATION OF CURRENT, VOLTAGE AND TEMPERATURE DURING THE HEAT CYCLE TEST



Electrical heat cycling test in water (test n° 9):
Registration on 02/04 & 03/04/2004

Model No. 17004
 Date Code 120000100
 Serial No. 20040402
 Start Time 03/04/2004 09:00:00
 Stop Time 03/04/2004 10:00:00
 Trigger Time 03/04/2004 09:00:00
 Trigger No. 47000
 Run Duration 60 min

Model No. 17004
 Date Code 120000100
 Serial No. 20040402
 Start Time 03/04/2004 09:00:00
 Stop Time 03/04/2004 10:00:00
 Trigger Time 03/04/2004 09:00:00
 Trigger No. 47000
 Run Duration 60 min

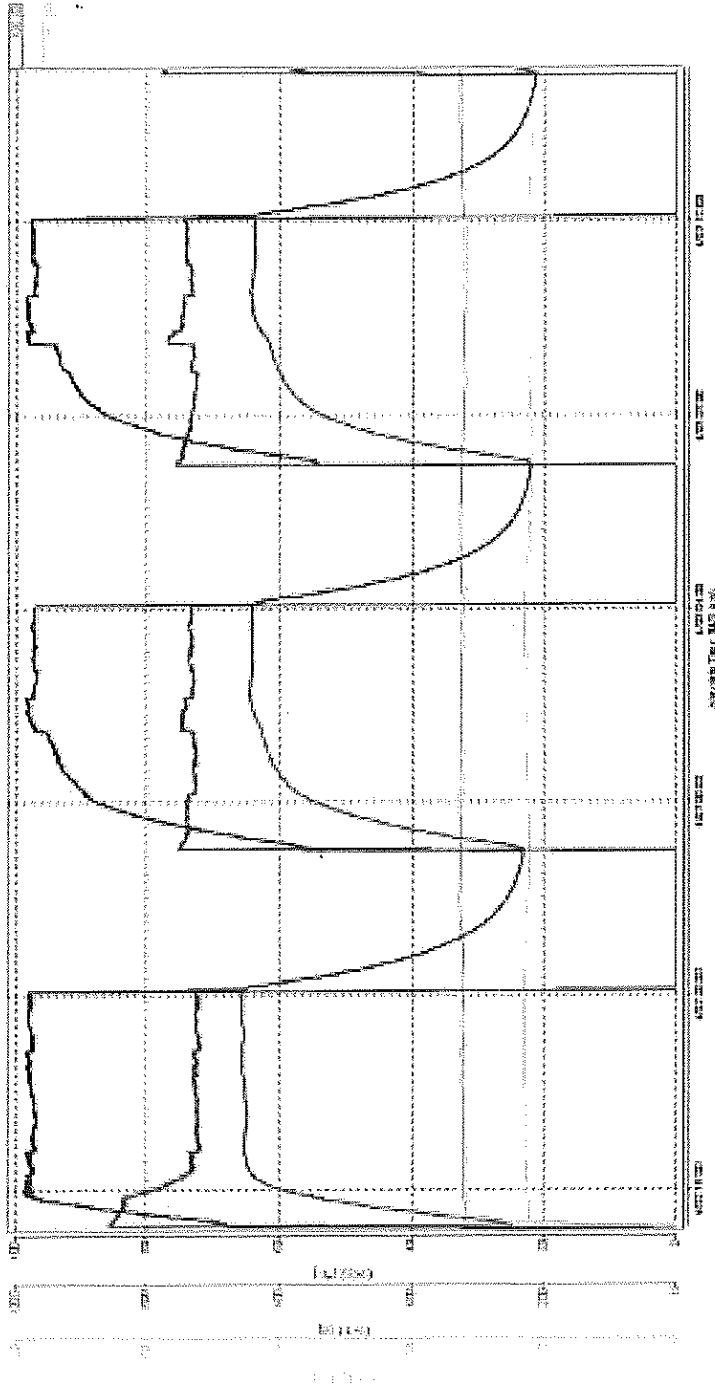

- Current (0-1000A)
- Voltage (0-100kV)
- Calculated conductor temperature (0-100°C)
- Cable jacket temperature (0-100°C)

**ВАРНО С
ОРИГИНАЛ**

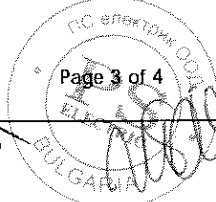

Handwritten signature

EXTRACT OF REGISTRATION OF CURRENT, VOLTAGE AND TEMPERATURE DURING THE HEAT CYCLE TEST



Registration on 22/04 & 23/04/2004

2
 Model No.
 Type Code
 Date of Issue
 Date of Test
 Test Time
 Test Location
 Test Operator
 Test Station
 Test Result

Model No.
 Type Code
 Date of Issue
 Date of Test
 Test Time
 Test Location
 Test Operator
 Test Station
 Test Result

Model No.
 Type Code
 Date of Issue
 Date of Test
 Test Time
 Test Location
 Test Operator
 Test Station
 Test Result

Model No.
 Type Code
 Date of Issue
 Date of Test
 Test Time
 Test Location
 Test Operator
 Test Station
 Test Result

Temperature
 recorded during
 constant

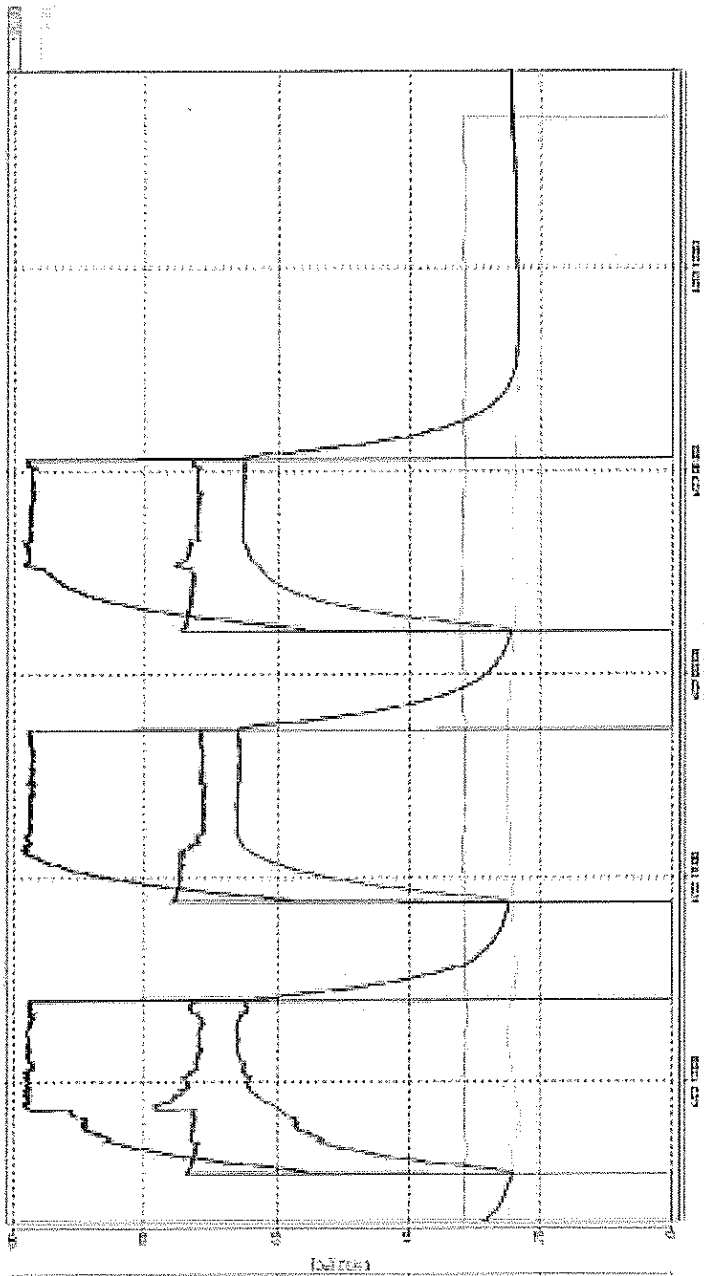

- Current (0-1000A)
- Voltage (0-100kV)
- Calculated conductor temperature (0-100°C)
- Cable jacket temperature (0-100°C)

Test report Nr TE 213 04 03

Appendix 3

ВЯРНО С
ОРИГИНАЛА

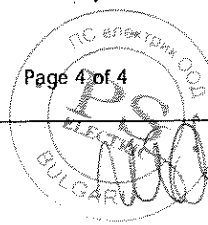

Page 4 of 4

Handwritten scribble at the top of the page.



EXTRACT OF REGISTRATION OF LIGHTNING IMPULSE WAVE SHAPE

Test n° 13: Impulse withstand voltage test at ambient temperature

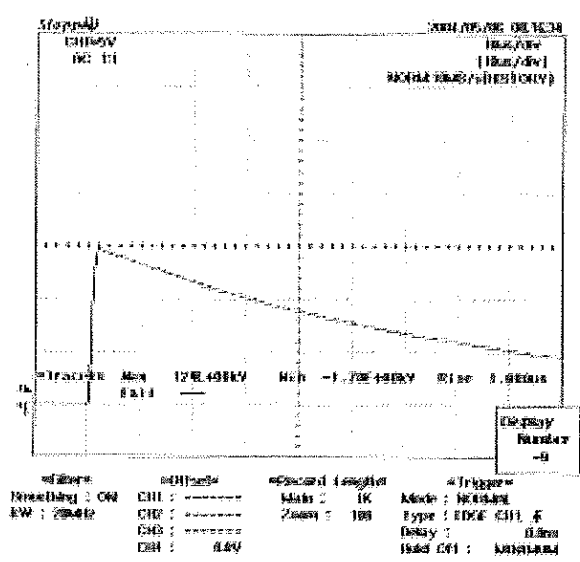

Shot 1 pos.

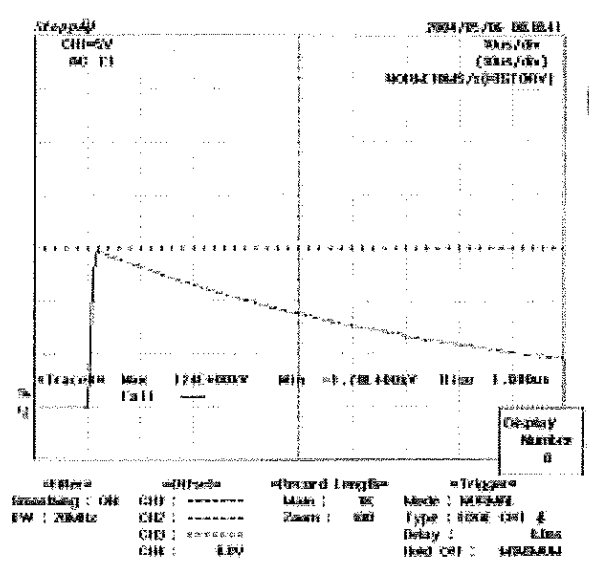

Shot 10 pos.

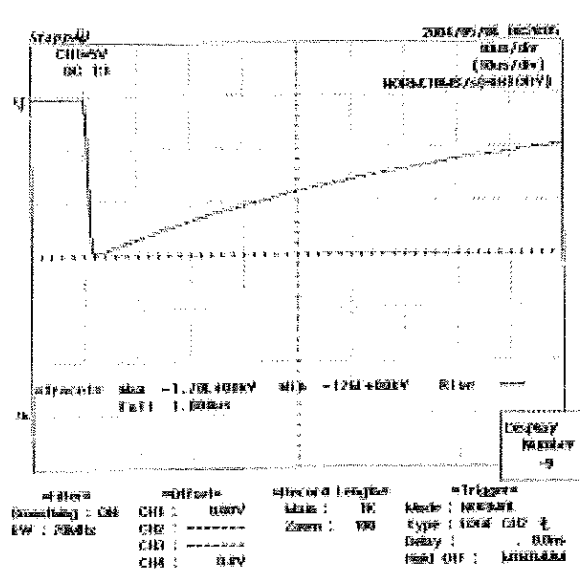

Shot 1 neg.

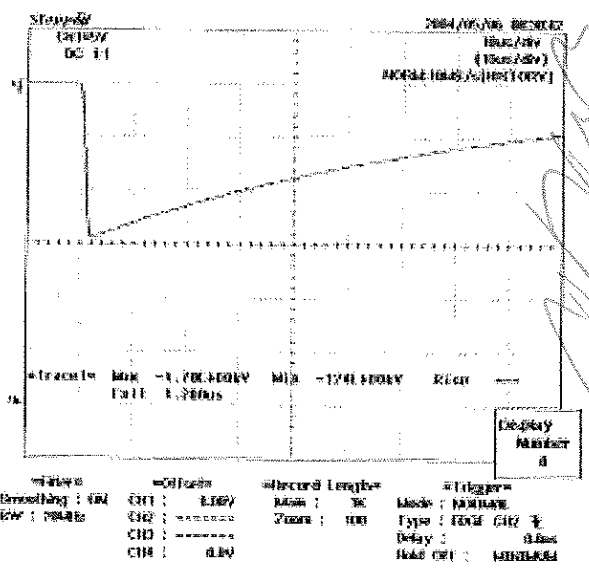

Shot 10 neg.

ВЯРНО С
ОРИГИНАЛА

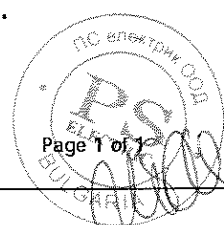

[Handwritten signature]

**TEST ARRANGEMENT (PICTURES) TABLE 7,
SEQUENCE D1**

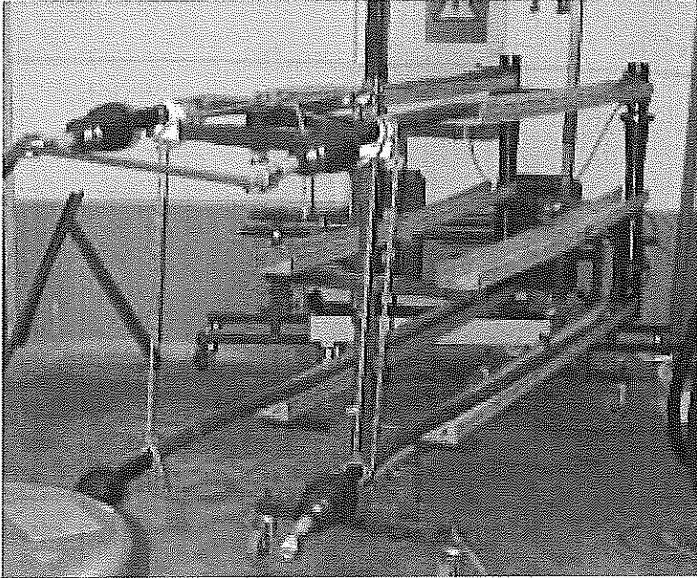

Test arrangement

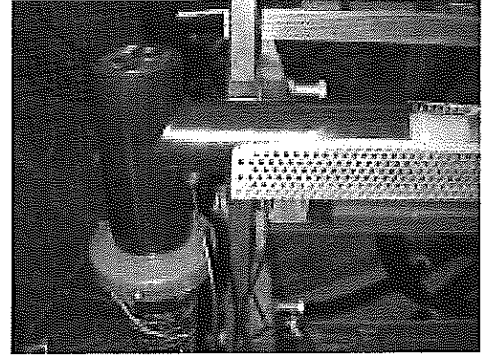

Test object

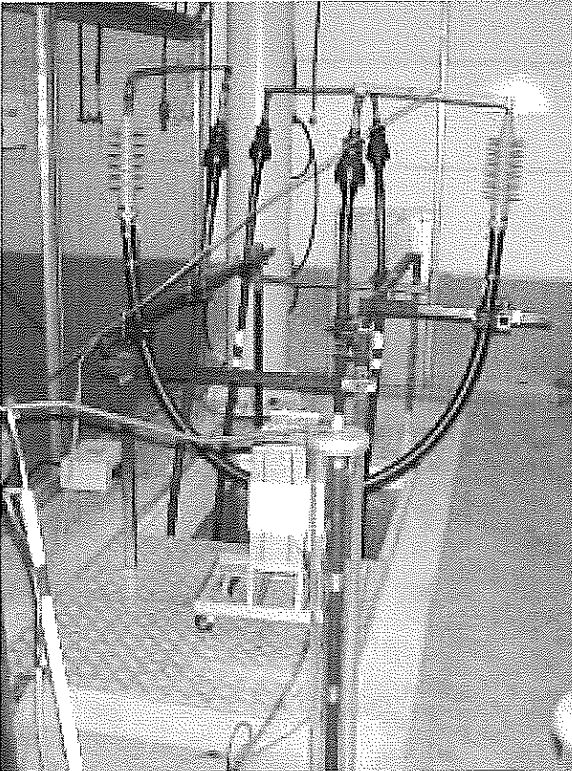

Test arrangement in water

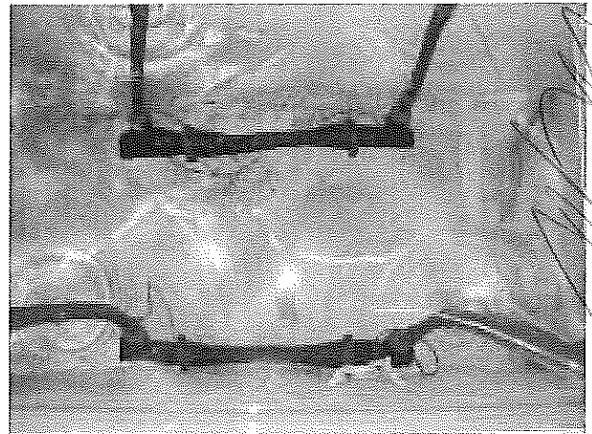

Test objects in water

**ВЯРНО С
ОРИГИНАЛА**

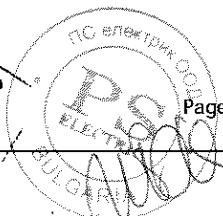

[Handwritten signature]

LIST OF EQUIPMENT USED



<u>Equipment N°</u>	<u>Description</u>	<u>Brand</u>	<u>Type</u>	<u>Serial N°</u>
DC withstand voltage test				
LI.053	Motorised control	ENV		II
LI.236	Transformer, HV-	MWB	TE0100/5	69/351774
LI.076	Diode	MWB	GS20	689655
LI.077	Diode	MWB	GS20	672377
LI.078	Capacitor DC	MWB	CS	689620
LI.067	Resistive divider/readout	F.C.ROBINSON		
LI.363	Transformer-fuse for DC			
AC withstand voltage test, dry				
LI.053	Motorised control	ENV		II
LI.236	Transformer, HV-	MWB	TE0100/5	69/351774
LI.067	Resistive divider/readout	F.C.ROBINSON		
PD test at ambient temperature				
LI.054	Motorised control	ENV		III
LI.169	Transformer, HV-	MWB	TEO 100/10	91/79489
LI.152	CAPACITOR, BLOCKING-	MWB	CK120	90/78472
LI.099	Capacitor, H.V. Injection-	F.C.ROBINSON		none
LI.049	Partial discharge detector	F.C.ROBINSON	700 MODEL 5	none
LI.011	Input unit	F.C.ROBINSON	701/4	152
LI.066	Resistive divider/readout	F.C.ROBINSON		
LI.001	Step wave generator	F.C.ROBINSON	751	none
Impulse withstand voltage test at elevated temperature				
LI.059	Transformer, induction-	ENV/ELEKTRAFO		none
LI.349	Recorder 12 channels	Yokogawa	DX 112-3-2	12A712788
LI.356	AC power supply	REO	REOLAB	5351/1
LI.366	Current measuring transformer	RS	B147	03/295055/2
LI.293	400kV impuls generator amplifier and rectifier	Haefely	33	4963-10
LI.294	400kV impuls generator Charging control	Haefely	222- **	
LI.350	Thermocouple-box 10 channels			
LI.295	400kV impuls generator Peak voltmeter	Haefely	65	SV65-08068J
LI.302	Oscilloscope	Yokogawa	DL1540	27WY0530D
PD test at elevated temperature				
LI.059	Transformer, induction-	ENV/ELEKTRAFO		none
LI.352	Thermocouple-box 10 channels			
LI.347	Recorder 12 channels	Yokogawa	DX 112-3-2	12A712791
LI.286	Multimeter	Metex Altai	M3800	750530
LI.357	AC power supply	REO	REOLAB	5351/2
LI.366	Current measuring transformer	RS	B147	03/295055/2
LI.244	Motorised control			8970/9
LI.132	Motorised control	MWB		
LI.130	Transformer, HV-	MWB	TEO100/20Z	79/45891
LI.106	Resistive divider/readout	ENV/CGS		

**ВЯРНО С
ОРИГИНАЛА**

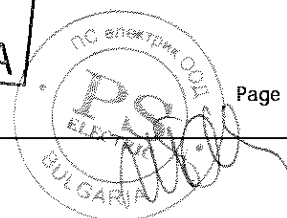



LIST OF EQUIPMENT USED

<u>Equipment N°</u>	<u>Description</u>	<u>Brand</u>	<u>Type</u>	<u>Serial N°</u>
<i>PD test at ambient temperature</i>				
LI.132	Motorised control	MWB		
LI.130	Transformer, HV-	MWB	TEO100/20Z	79/45891
LI.337	PD calibrator + 100pF capacitor	Power diagnostix	Cal1C	
LI.106	Resistive divider/readout	ENV/CGS		
LI.347	Recorder 12 channels	Yokogawa	DX 112-3-2	12A712791
LI.338	PD Detector (disp. +AB1 +2xCIL4L+2x PRA1)	Power diagnostix		
<i>Electrical heat cycling in air and water</i>				
LI.059	Transformer, induction-	ENV/ELEKTRAFO		none
LI.351	Thermocouple-box 10 channels			
LI.347	Recorder 12 channels	Yokogawa	DX 112-3-2	12A712791
LI.286	Multimeter	Metex Altai	M3800	750530
LI.357	AC power supply	REO	REOLAB	5351/2
LI.366	Current measuring transformer	RS	B147	03/295055/2
LI.244	Motorised control			8970/9
LI.246	Transformer, HV-	MWB	TEO 100/50	376695
LI.112	Resistive divider/readout	ENV/CGS		
<i>PD test at elevated temperature</i>				
LI.340	Voltage regulator	REO	REOLAB	18 03132-01-1
LI.358	AC power supply	REO	REOLAB	5351/3
LI.246	Transformer, HV-	MWB	TEO 100/50	376695
LI.059	Transformer, induction-	ENV/ELEKTRAFO		none
LI.351	Thermocouple-box 10 channels			
LI.366	Current measuring transformer	RS	B147	03/295055/2
LI.338	PD Detector (disp. +AB1 +2xCIL4L+2x PRA1)	Power diagnostix		
LI.337	PD calibrator + 100pF capacitor	Power diagnostix	Cal1C	
LI.346	Recorder 12 channels	Yokogawa	DX 112-3-2	12AA22203
LI.112	Resistive divider/readout	ENV/CGS		
<i>PD test at ambient temperature</i>				
LI.340	Voltage regulator	REO	REOLAB	18 03132-01-1
LI.338	PD Detector (disp. +AB1 +2xCIL4L+2x PRA1)	Power diagnostix		
LI.337	PD calibrator + 100pF capacitor	Power diagnostix	Cal1C	
LI.346	Recorder 12 channels	Yokogawa	DX 112-3-2	12AA22203
<i>Impulse withstand voltage test at ambient temperature</i>				
LI.293	400kV impuls generator amplifier and rectifier	Haefely	33	4963-10
LI.294	400kV impuls generator Charging control	Haefely	222- **	
LI.295	400kV impuls generator Peak voltmeter	Haefely	65	SV65-08068J
LI.302	Oscilloscope	Yokogawa	DL1540	27WY0530D
<i>AC withstand voltage test, dry</i>				
LI.340	Voltage regulator	REO	REOLAB	18 03132-01-1
LI.246	Transformer, HV-	MWB	TEO 100/50	376695
LI.112	Resistive divider/readout	ENV/CGS		
LI.346	Recorder 12 channels	Yokogawa	DX 112-3-2	12AA22203

ВЯРНО С
ОРИГИНАЛА

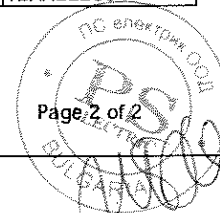

[Handwritten signature]



INSTALLATION INSTRUCTION

430TB-630A

Ref. nr. IS 430TB-630A-E-45
90722E-R/1

[Handwritten signature]

ВЯРНО С
ОРИГИНАЛА

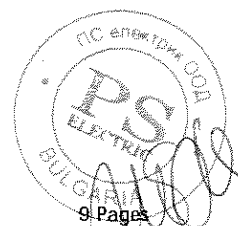

[Handwritten signature]

CAUTION : Read instructions thoroughly and completely prior to beginning installation.

Installation Instructions

430TB-630A

Separable Tee Connector - Type C interface

Only to be used on copper wire screened cable with extruded easy strip or bonded semi-conductive screen

Required components for the connector installation :

3 x Tee connector housing - 430BT

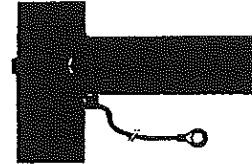

3 x Cable reducer - 430CA-W

EUROMOLD - E-LAB



3 x Clamping screw - 400TCSR

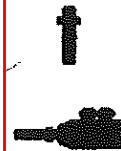
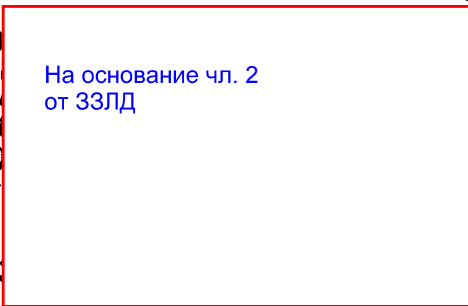

3 x Conductor contact - CMBC-X



3 x Basic insulating plug + cap -



1 x Installation rod

(optional use for conductor sizes 185 & 240 mm²)



- Water sealing mastic, type MWS
- Field control mastic, type MFC (optional use for easy strip semi-conductive screened cable)
- Silicone grease + wipers
- Installation instructions + crimp chart

90722E-R40 This product should be installed only by competent personnel trained in good safety practices involving high voltage electrical equipment. These instructions are not intended as a substitute for adequate training or experience in such safety practices. These instructions do not attempt to provide for every possible contingency. Failure to follow these instructions could result in damage to the product and serious or fatal injury. **IMPORTANT : Cable and associated apparatus must be de-energised, locked out, and tagged prior to product installation.**

**ВЯРНО С
ОРИГИНАЛА**

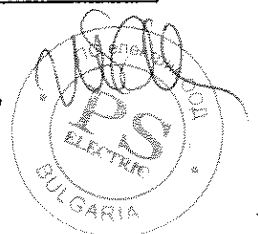

[Handwritten signature]

76

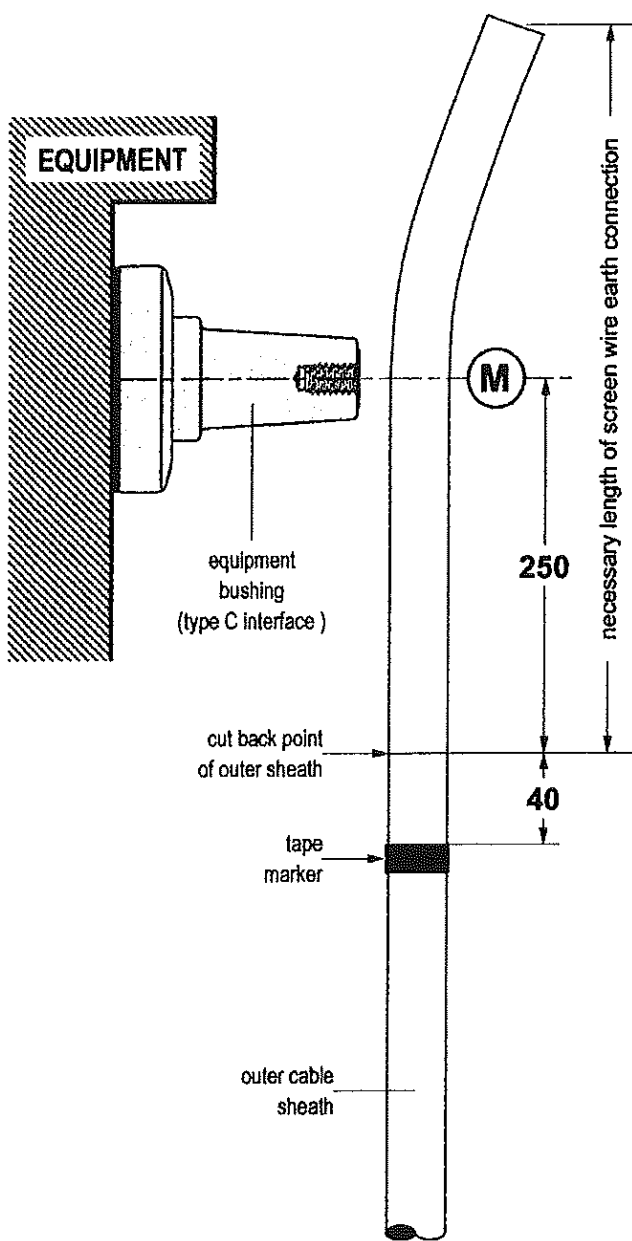

1. Train the cable into the approximate finished position next to the equipment bushing. Be sure to allow enough extra length of concentric wires to connect to the earth system.
2. Mark centre line «M» of the bushing.
3. Remove the outer cable sheath to a point 250 mm from the centre line «M» of the bushing.
4. Apply a tape marker around the outer sheath 40 mm from the cut back point.

На основание чл. 2
от ЗЗЛД

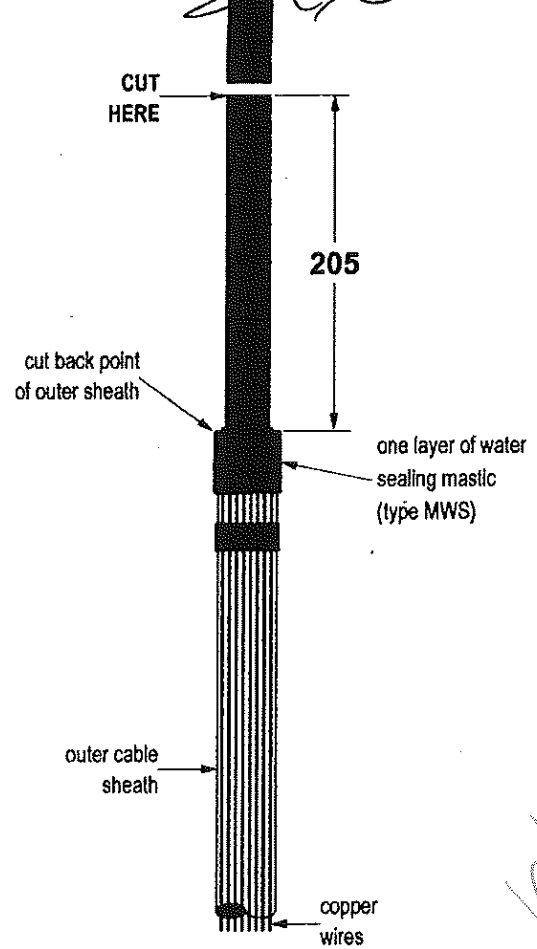

5. Wrap one layer of water sealing mastic (type MWS) around the outer sheath, flush with the cut back point (25 mm minimum width). Completely encircle the cable.
6. Bend the screen wires back over the mastic and along the outer sheath, pressing them into the mastic.
IMPORTANT: screen wires should not touch each other when pressed into the mastic to prevent water ingress.
7. Cut the cable to a point 205 mm from the outer sheath.

ВЯРНО С
ОРИГИНАЛА

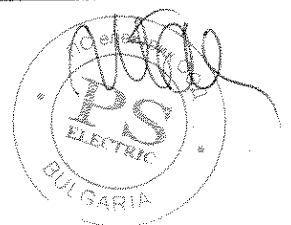

86

CABLE PREPARATION

For extruded easy strip semi-conductive screen

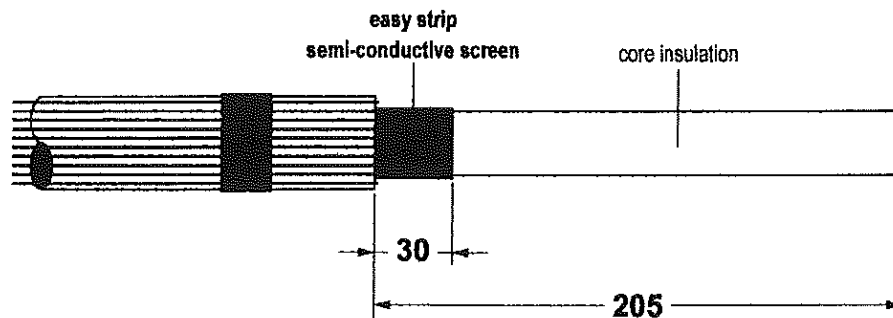

1. Check distance of 205 mm.
2. Remove the easy strip semi-conductive screen up to a point 30 mm from the outer sheath end. Cut squarely taking care not to cut the core insulation.

На основание чл. 2
от ЗЗЛД

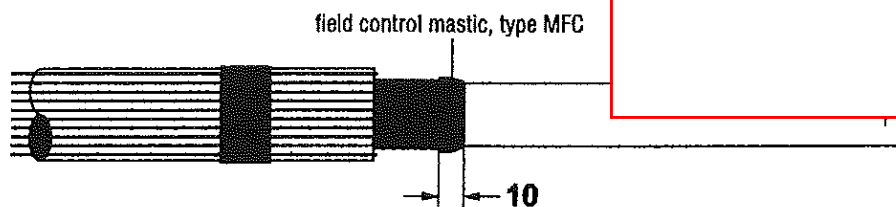

3. Remove field control mastic strip, type MFC, from coated paper.
4. Slightly stretch one end of the strip, making sure not to break it.
5. Apply the mastic on the cutback edge of the semi-conductive screen, covering approximately 5 mm of the extruded semi-conductive screen and 5 mm of the core insulation.
6. Push the mastic in place while stretching it progressively until both ends overlap and tear-off the excess mastic.
7. Using the coated side of the paper, squeeze the mastic tightly in place on the step of the semi-conductive screen.
8. REMOVE ANY TRACES OF CONDUCTIVE RESIDUE FROM THE CORE INSULATION.

For bonded extruded semi-conductive screen

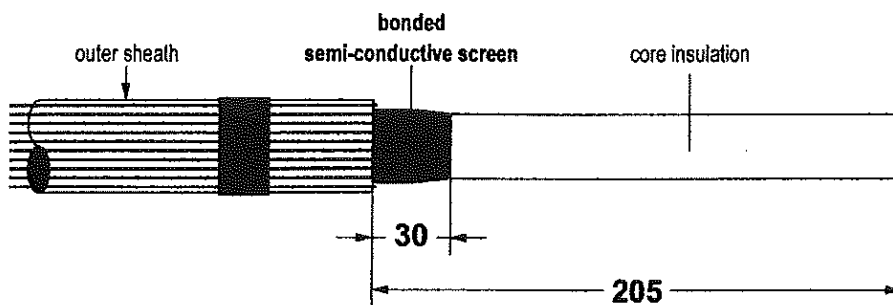

1. Check distance of 205 mm.
2. Remove the bonded semi-conductive screen up to a point 30 mm from the outer sheath end. Use a suitable stripping tool.
3. REMOVE ANY TRACES OF CONDUCTIVE RESIDUE FROM THE CORE INSULATION.

ВЯРНО С
ОРИГИНАЛА

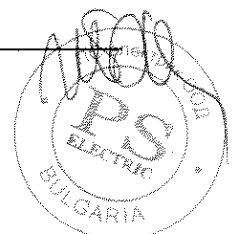

REMOVAL OF THE CORE INSULATION

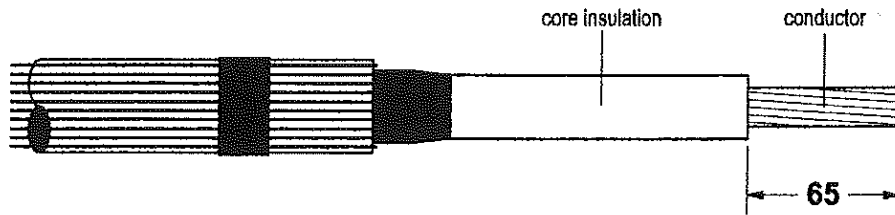

1. Remove the core insulation from the conductor for a distance of 65 mm.

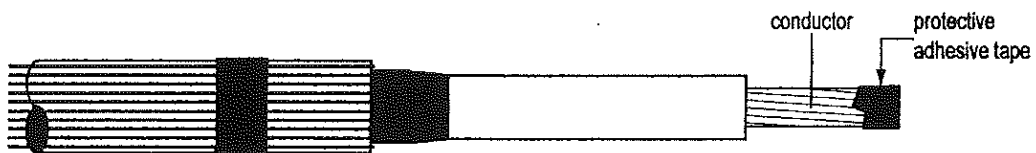

2. As a protection, wrap a few turns of adhesive tape around the conductor end.

INSTALLATION OF THE CABLE REDUCER

For conductor sizes 95 - 120 & 150 mm²

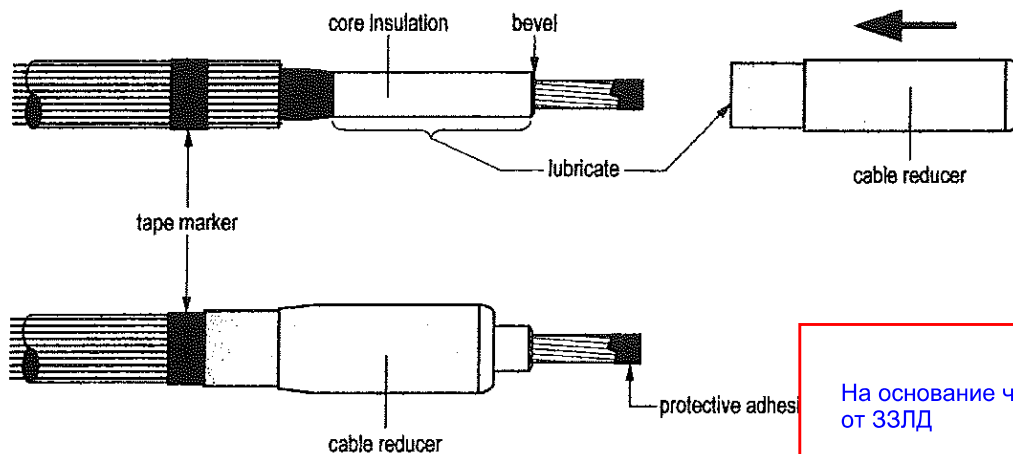

1. Slightly bevel the edge of the core insulation.
2. **THOROUGHLY CLEAN CORE INSULATION.** Always wipe towards the screen wire.
3. Lubricate* core insulation and the inside surface of the cable reducer.
4. Slide the reducer down the cable until flush with the tape marker.
5. Remove protective adhesive tape from the conductor.

На основание чл. 2
от ЗЗЛД

* USE ONLY THE SILICONE LUBRICANT SUPPLIED

ВЯРНО С
ОРИГИНАЛА

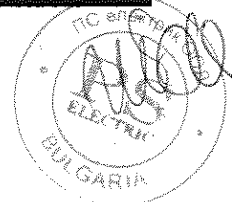

lof

For conductor sizes 185 & 240 mm²

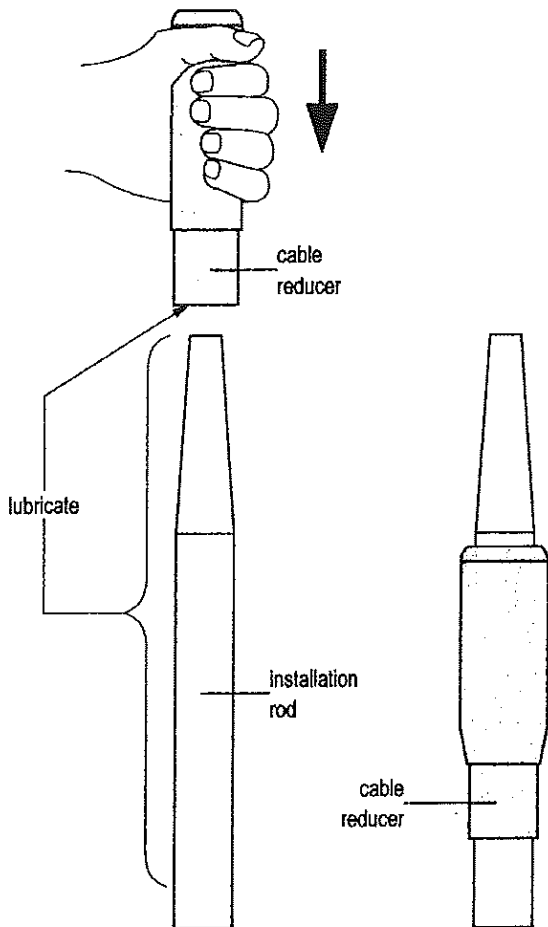

На основание чл. 2
от ЗЗЛД

1. THOROUGHLY CLEAN INSTALLATION ROD.
2. Lubricate* installation rod and the inside surface of the cable reducer.
3. Slide the reducer down the installation rod.

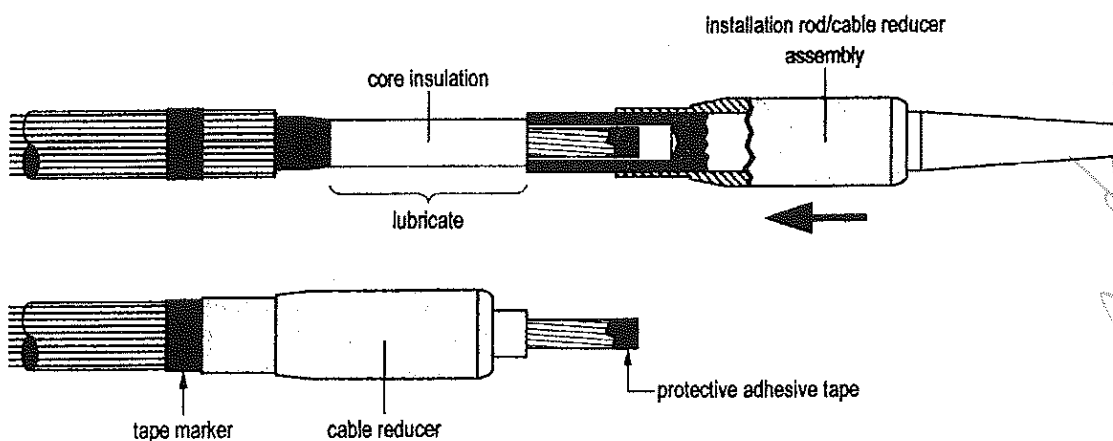

4. THOROUGHLY CLEAN CORE INSULATION. Always wipe towards the screen wires.
5. Lubricate* core insulation.
6. Slide the reducer down the cable until flush with the tape marker. Take care to slide the reducer without hesitation and in one smooth move.
7. Remove protective adhesive tape from the conductor.

* USE ONLY THE SILICONE LUBRICANT SUPPLIED

ВЯРНО С
ОРИГИНАЛА

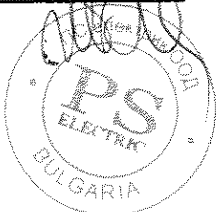

CRIMPING OF THE CONTACT

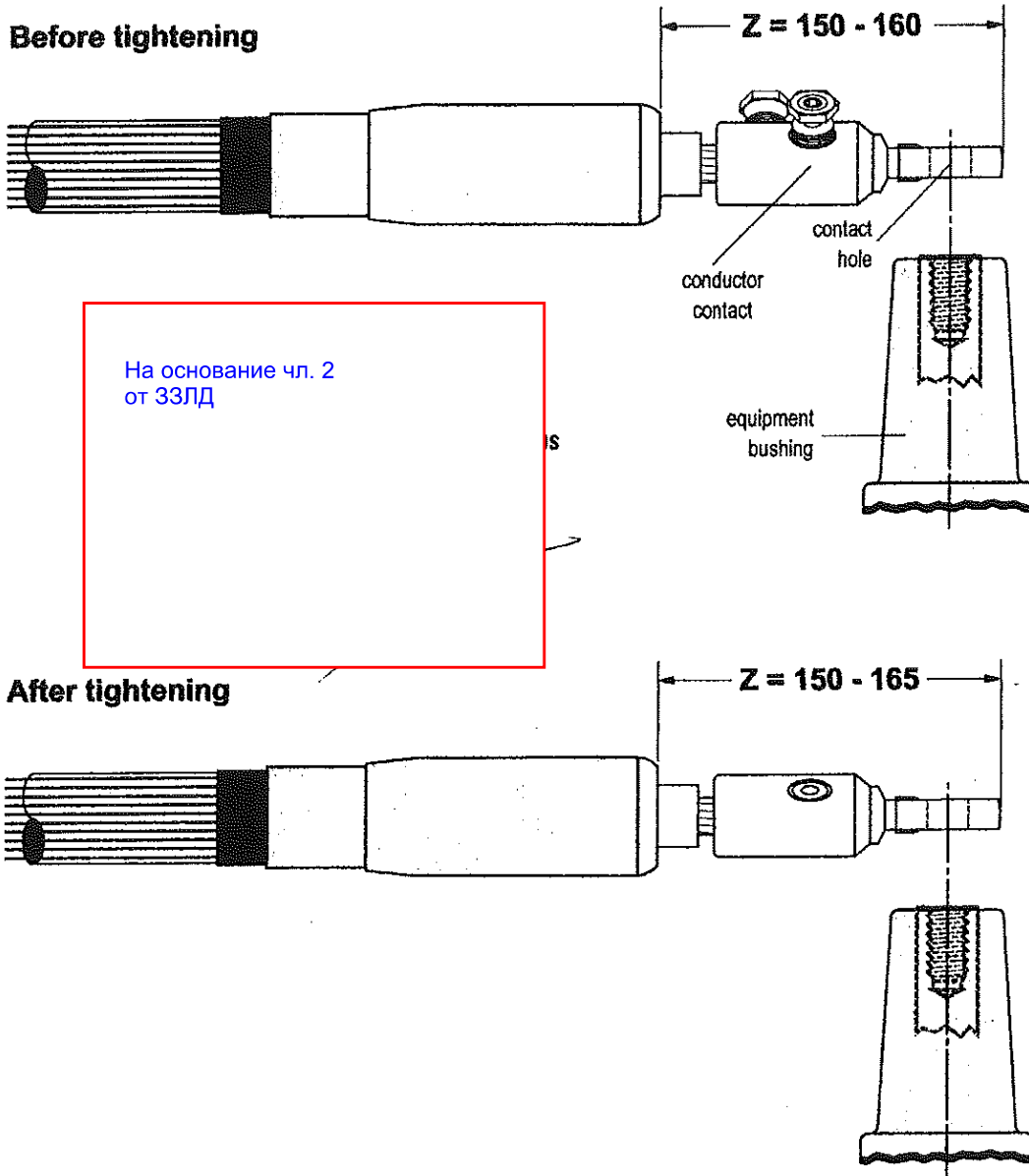

1. Fit the mechanical contact onto the conductor. If necessary, first insert the appropriate centre ring into the contact bore.
2. Position the contact so that the contact hole aligns with the bushing hole.
3. Before tightening, distance «Z» must be between 150 and 160 mm.
4. Tighten the contact in accordance with the manufacturer's instructions.
5. After tightening, distance «Z» must be between 155 and 165 mm.
6. WIPE-OFF EXCESS INHIBITOR AND REMOVE ANY BURRS RESULTING FROM TIGHTENING.

ВЯРНО С
ОРИГИНАЛА

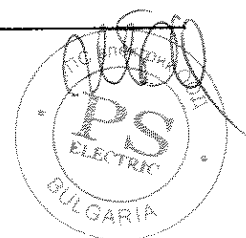

CONNECTOR INSTALLATION ON CABLE

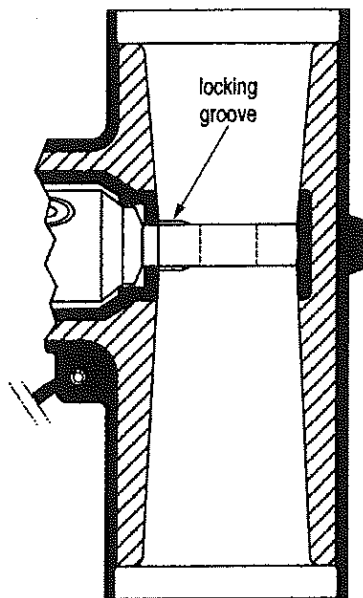
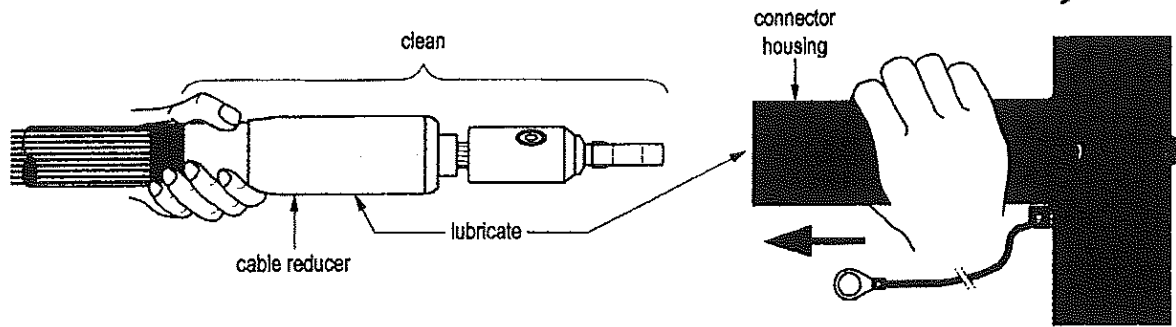

1. Clean cable reducer, core insulation and contact.
2. Lightly lubricate* the inside surface of the connector housing and outer surface of the cable reducer.
3. Check if the angle of the tee connector housing is correct relative to the palm of the crimp contact and the **longer interface is pointed towards the bushing**. Whilst preventing the cable reducer from further movement down the cable, gently slide the housing on the cable until it cannot advance any further.
4. Make sure the contact spade locks into the connector's housing. Check correct installation by trying to pull back the connector. It is correctly installed when it stays in its locked position.
5. The cable reducer must stay in place during installation.
6. Remove tape marker from the cable.

CONNECTOR INSTALLATION ON BUSHING

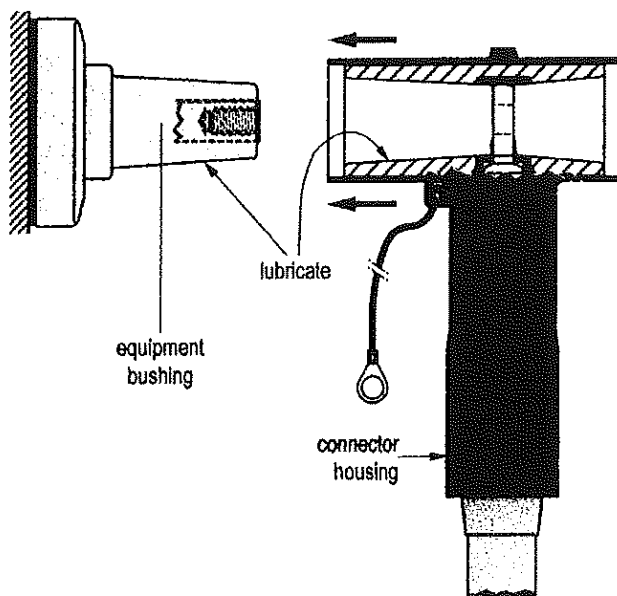

На основание чл. 2
от ЗЗЛД

1. Clean and lightly lubricate* both connector and bushing interface.
2. Push the connector on to the bushing.

USE ONLY THE SILICONE LUBRICANT SUPPLIED

ВЯРНО С
ОРИГИНАЛА

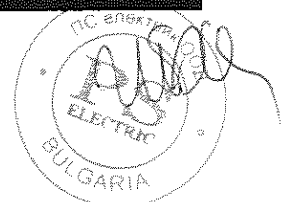

136

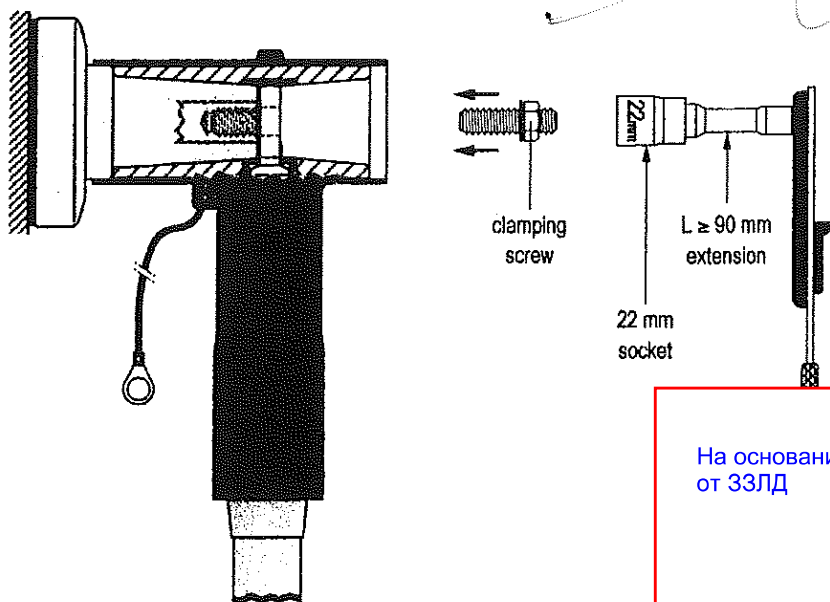

На основание чл. 2
от ЗЗЛД

3. Insert clamping screw into the threaded hole of the bushing.
4. Use torque wrench with a socket wrench 22 and tighten exerting 50 Nm (5 kgm or 35 foot-pounds) of torque
In order to achieve the correct applied torque ensure that there is no lubricant on the threaded parts.

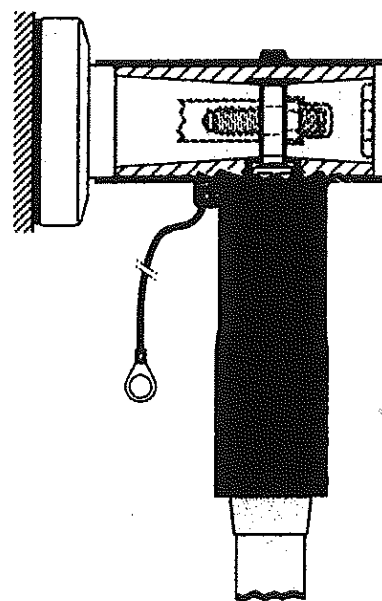
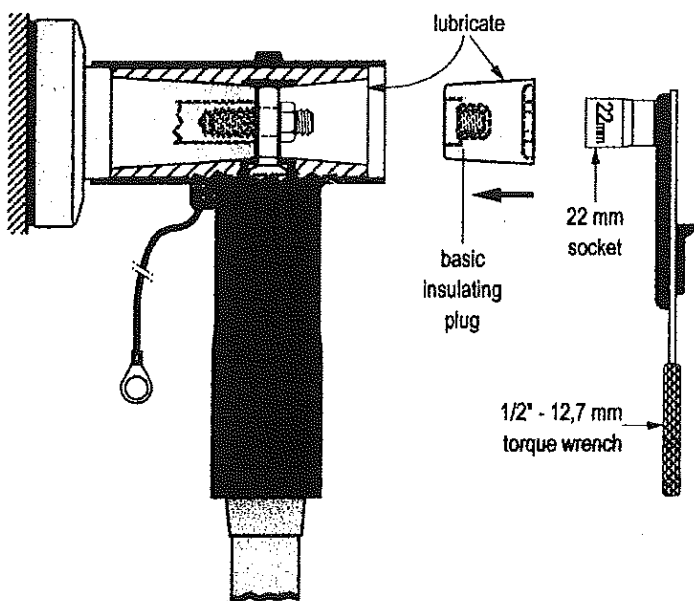

500/12

5. Clean and lightly lubricate* both connector and basic insulating plug interface.
6. Insert the plug in the connector interface and tighten assembly : use torque wrench with socket of 22 and tighten exerting 10 Nm (1 kgm or 7,23 foot-pounds) of torque.
In order to achieve the correct applied torque ensure that there is no lubricant on the threaded parts.

USE ONLY THE SILICONE LUBRICANT SUPPLIED

[Handwritten signature]

ВЯРНО С
ОРИГИНАЛА

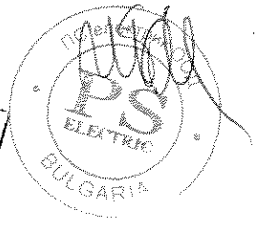

CONNECTOR EARTHING AND CABLE CLAMPING

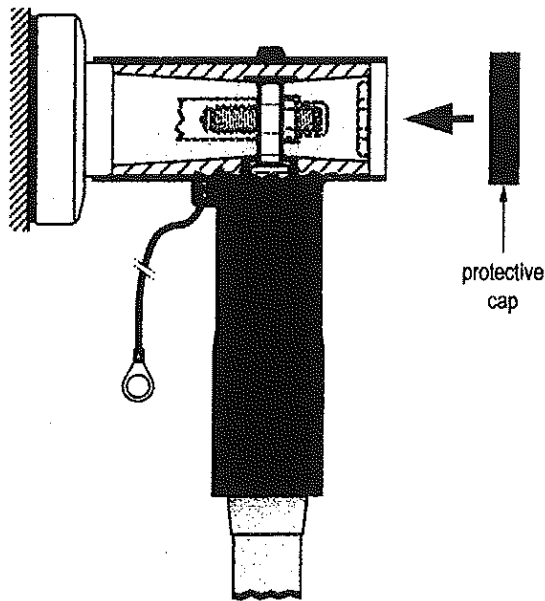

На основание чл. 2
от ЗЗЛД

8. Clean inside of cap and push cap onto the basic insulating plug. Slightly pull up the edge of the cap to exhaust the air during assembly.

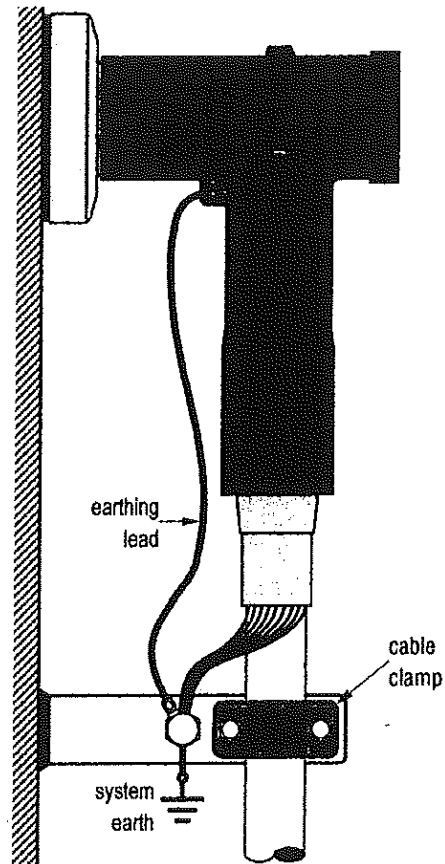

1. Bend back the screen wires along the outer sheath to form a pig tail.
2. Connect the earthing lead and screen wires to system earth.

USE ONLY THE SILICONE LUBRICANT SUPPLIED

NOTE :

A connector/bushing mated combination should not be allowed to carry the full weight of the cable.

Therefore clamp the cable as close as possible to the connector.

IMPORTANT NOTES :

- Never disconnect the connector from energised equipment nor energise a disconnected connector without previously installing on its appropriate corresponding mating part.
- Do not allow hydrocarbon oils or solvents to contaminate the E.P.D.M. rubber.
In the event of contamination, wipe the surface clean with a dry cloth.

Euromold
a Nexans company

EUROMOLD N.V.
Zuid III - Industrielaan 12
B-9320 EREMBODEGEM-AALST - BELGIUM
Tel: +32 (0)53/85 02 11 - Telefax: +32 (0)53/83 10 13

ВЪРНО С
ОРИГИНАЛА

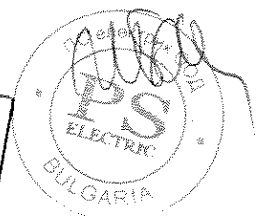

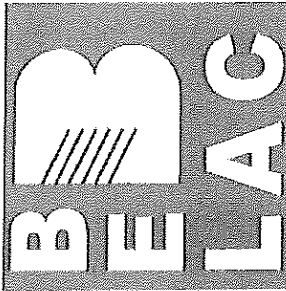

Organisme belge d'Accréditation
 Belgische Accreditatieinstelling
 Belgische Akkreditierungsstelle
 Belgian Accreditation Body

Signatory to EA, ILAC and IAF
 Multilateral Agreements

Accreditation Certificate No. 144-TEST

In compliance with the provisions of the Royal Decree of 31 January 2006 setting up BELAC, the Accreditation Board hereby declares, that the test laboratory

NEXANS NETWORK SOLUTIONS NV
DIV. EUROMOLD
ELAB
Industrielaan, 12 - Zuid III
9320 EREMBODEGEM - Belgium

has the competence to perform the tests as described in the annex which is an integral part of the present certificate, in accordance with the requirements of the standard NBN EN ISO/IEC 17025:2005. The present accreditation is the subject of regular surveillance in order to confirm the compliance with the accreditation conditions.

The Chair of the Accreditation Board BELAC,

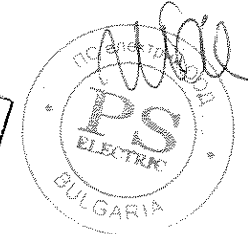

ВЯРНО С
 ОРИГИНАЛА

Issue date : **2011-09-06**
 Validity date : **2016-06-14**

Original version of this certificate is in Dutch.

На основание
 Чл. 2
 от ЗЗЛД

EM

.be

4

[Handwritten signature]

Deutsche Akkreditierungsstelle GmbH

Beliehene gemäß § 8 Absatz 1 AkkStelleG i.V.m. § 1 Absatz 1 AkkStelleGBV
Unterzeichnerin der Multilateralen Abkommen
von EA, ILAC und IAF zur gegenseitigen Anerkennung

Akkreditierung



Die Deutsche Akkreditierungsstelle GmbH bestätigt hiermit, dass das Prüflaboratorium

RWE Eurotest GmbH
Unterste-Wilms-Str. 52, 44143 Dortmund

die Kompetenz nach DIN EN ISO/IEC 17025:2005 besitzt, Prüfungen in folgenden Bereichen durchzuführen:

Hochspannungsgeräte und -anlagen, Niederspannungs-Schaltgeräte-Kombinationen, Kabel, Starkstromkabel-Garnituren, Press- und Schraubverbinder, Isolierstoffe (Isolieröle), EMV, Erdungsanlagen, sowie von PSA bei Lichtbogeneinwirkung

Die Akkreditierungsurkunde gilt nur in Verbindung mit dem Bescheid vom 18.10.2011 mit der Akkreditierungsnummer D-PL-15207-01 und ist gültig bis 17.10.2016. Sie besteht aus diesem Deckblatt, der Rückseite des Deckblatts und der folgenden Anlage mit insgesamt 6 Seiten.

Registrierungsnummer der Urkunde: **D-PL-15207-01-01**

Frankfurt am Main, 18.10.2011

Siehe Hinweise auf der Rückseite

[Handwritten signature]

На основание чл. 2
от ЗЗЛД

ВЯРНО С
ОРИГИНАЛА

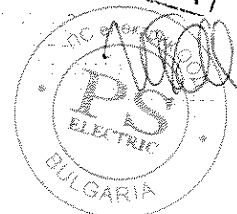

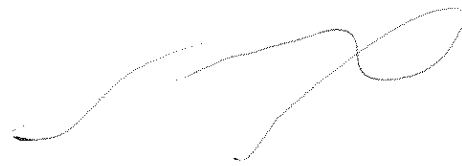

Deutsche Akkreditierungsstelle GmbH

Standort Berlin
Spittelmarkt 10
10117 Berlin

Standort Frankfurt am Main
Gartenstraße 6
60594 Frankfurt am Main

Standort Braunschweig
Bundesallee 100
38116 Braunschweig

Die auszugsweise Veröffentlichung der Akkreditierungsurkunde bedarf der vorherigen schriftlichen Zustimmung der Deutsche Akkreditierungsstelle GmbH (DAkKS). Ausgenommen davon ist die separate Weiterverbreitung des Deckblattes durch die umseitig genannte Konformitätsbewertungsstelle in unveränderter Form.

Es darf nicht der Anschein erweckt werden, dass sich die Akkreditierung auch auf Bereiche erstreckt, die über den durch die DAkKS bestätigten Akkreditierungsbereich hinausgehen.

Die Akkreditierung erfolgte gemäß des Gesetzes über die Akkreditierungsstelle (AkkStelleG) vom 31. Juli 2009 (BGBl. I S. 2625) sowie der Verordnung (EG) Nr. 765/2008 des Europäischen Parlaments und des Rates vom 9. Juli 2008 über die Vorschriften für die Akkreditierung und Marktüberwachung im Zusammenhang mit der Vermarktung von Produkten (Abl. L 218 vom 9. Juli 2008, S. 30). Die DAkKS ist Unterzeichnerin der Multilateralen Abkommen zur gegenseitigen Anerkennung der European co-operation for Accreditation (EA), des International Accreditation Forum (IAF) und der International Laboratory Accreditation Cooperation (ILAC). Die Unterzeichner dieser Abkommen erkennen ihre Akkreditierungen gegenseitig an.

Der aktuelle Stand der Mitgliedschaft kann folgenden Webseiten entnommen werden:

EA: www.european-accreditation.org

ILAC: www.ilac.org

IAF: www.iaf.nu

ВЯРНО С
ОРИГИНАЛА

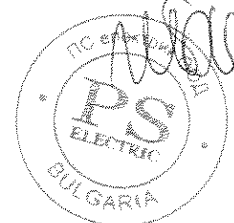



Deutsche Akkreditierungsstelle GmbH

Anlage zur Akkreditierungsurkunde D-PL-15207-01-01 nach DIN EN ISO/IEC 17025:2005

Gültigkeitsdauer: 18.10.2011 bis 17.10.2016

Urkundeninhaber:

RWE Eurotest GmbH
Unterste-Wilms-Str. 52, 44143 Dortmund

Prüfungen in den Bereichen:

Fachbereich	Norm/ Hausverfahren/ Version	Titel der Norm oder des Hausverfahrens ¹ (ggf. Abweichungen / Modifizierungen von Normverfahren angeben)	Prüfbereich/ Einschränkung
Hochspan- nungsgeräte und -anlagen	VDE 0432 Teil 1 HD 588.1 S1 DIN IEC 60060-1 IEC 60060-1	Hochspannungs-Prüftechnik – Teil 1: Allgemeine Festlegungen und Prüfbedingungen	Prüfbereich: Wechselspannung bis 600 kV Gleichspannung bis 350 kV Stoßspannung 1,2/50 µs bis 1,6 MV 250/2500 µs bis 1,2 MV
	VDE 0434 DIN EN 60270 EN 60270 IEC 60270	Hochspannungs-Prüftechnik – Teilentladungsmessungen	

ВЯРНО С
ОРИГИНАЛА

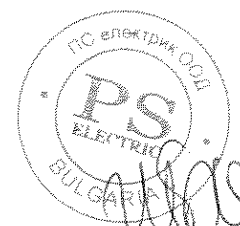

¹ Im Titel des Hausverfahrens sind Methode und Prüfgegenstand zu nennen

Fachbereich	Norm/ Hausverfahren/ Version	Titel der Norm oder des Hausverfahrens ¹ (ggf. Abweichungen / Modifizierungen von Normverfahren angeben)	Prüfbereich/ Einschränkung
	VDE 0682 Teil 411 DIN EN 61243-1 EN 61243-1 IEC 61243-1	Arbeiten unter Spannung – Spannungsprüfer – Teil 1: Kapazitive Ausführung für Wechselspannungen über 1 kV	<u>Einschränkung:</u> keine <ul style="list-style-type: none"> ▪ Rüttelfestigkeit Abs. 6.4.3 ▪ Fallfestigkeit Abs. 6.4.4 ▪ Klimafestigkeit Abs. 6.4.6 ▪ Einfluss der ein. gem. Abs. 6.2.6 ▪ Frequenzabhängigkeit gem. Abs. 5.2.5 ▪ Zweifelsfreie Wahrnehmbarkeit gem. Abs. 6.2.3.1 und 6.2.2.1 ▪ Prüfung der Eigenprüfvorrichtung gem. Abs. 6.2.7
	VDE 0682 Teil 431 DIN EN 61481 EN 61481 IEC 61481	Arbeiten unter Spannung – Phasenvergleich für Wechselspannungen von 1 kV bis 36 kV	<u>Einschränkung:</u> keine <ul style="list-style-type: none"> ▪ Rüttelfestigkeit Abs. 5.4.4 ▪ Fallfestigkeit Abs. 5.4.5 ▪ Festigkeit der Verbindungsleitung,.. gem Abs. 5.4.3 ▪ Klimafestigkeit Abs. 5.4.7 ▪ Einfluss der ein. gem. Abs. 5.2.7 ▪ Frequenzabhängigkeit gem. 5.2.5 ▪ Zweifelsfreie Wahrnehmbarkeit gem. Abs. 5.2.4 ▪ Kontrolle der Eigenprüfvorrichtung gem. Abs. 5.2.8
	DIN VDE 0101 HD 637 S1	Starkstromanlagen mit Nennspannungen über 1 kV	<u>Einschränkung:</u> nur Erdungsmessungen gemäß Anhang N

Gültigkeitsdauer: 18.10.2011 bis 17.10.2016

ВАРНО С
ОРИГИНАЛА



Fachbereich	Norm/ Hausverfahren/ Version	Titel der Norm oder des Hausverfahrens ¹ (ggf. Abweichungen / Modifizierungen von Normverfahren angeben)	Prüfbereich/ Einschränkung
Niederspannungsgeräte und -anlagen	VDE 0660 Teil 600-1 DIN EN 61439-1 EN 61439-1 IEC 61439-1	Niederspannungs-Schaltgerätekombinationen; Teil 1: Allgemeine Festlegungen	
	VDE 0660 Teil 600-5 DIN EN 61439-5 EN 61439-5 IEC 61439-5	Niederspannungs-Schaltgerätekombinationen; Teil 5: Schaltgerätekombinationen in öffentlichen Energieversorgungsnetzen	
	VDE 0660 Teil 505 DIN VDE 0660-505	Niederspannungs-Schaltgerätekombinationen; Teil 505: Bestimmung für Hausanschlusskästen und Sicherungskästen	
	VDE 0682-1-2 DIN EN 61482-1-2	Arbeiten unter Spannung - Schutzkleidung gegen die thermischen Gefahren eines elektrischen Lichtbogens - Teil 1- 2: Prüfverfahren - Verfahren 2: Bestimmung der Lichtbogen- Schutzklasse des Materials und der Kleidung unter Verwendung eines gerichteten Prüflichtbogens (Box-Test)	
	GS-ET-29	BG-Prüfzert: Zusatzanforderungen für die Prüfung und Zertifizierung von Elektriker-Gesichtsschutz	
	PIP001	RWE Eurotest GmbH: Prüfung der Störlichtbogenfestigkeit von Schutzkleidung	
	VDE 0122-1; DIN EN 61851-1; IEC 61851-1	Elektrische Ausrüstung von Elektro-Straßenfahrzeugen - Konduktive Ladesysteme für Elektrofahrzeuge - Teil 1: Allgemeine Anforderungen	
	VDE 0122-2-2; DIN EN 61851-22; IEC 61851-22	Elektrische Ausrüstung von Elektro-Straßenfahrzeugen - Konduktive Ladesysteme für Elektrofahrzeuge - Teil 2-2: Wechselstrom-Ladestation für Elektrofahrzeuge	
EMV-Prüfungen	DIN EN 50160	Merkmale der Spannung in öffentlichen Elektrizitätsversorgungsnetzen	<u>Prüfbereich:</u> Messungen bis 1000V und 1000 A
	DIN EN 50413 (VDE 0848-1)	Grundnorm zu Mess- und Berechnungsverfahren der Exposition von Personen in elektrischen, magnetischen und elektromagnetischen Feldern (0 Hz bis 300 GHz);	<u>Prüfbereich:</u> Messung der elektrischen und magnetischen Felder von 0-30 kHz
Kabel und Leitungen	VDE 0271 DIN VDE 0271	Starkstromkabel - Festlegungen für Starkstromkabel ab 0,6/1 kV für besondere Anwendungen	<u>Einschränkung:</u> kein ▪ Brennverhalten

Gültigkeitsdauer: 18.10.2011 bis 17.10.2016

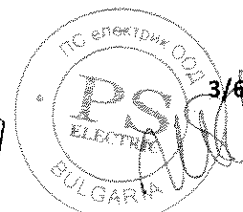
 ВЯРНО С
 ОРИГИНАЛА



Anlage zur Akkreditierungsurkunde D-PL-15207-01-01

Fachbereich	Norm/ Hausverfahren/ Version	Titel der Norm oder des Hausverfahrens ¹ (ggf. Abweichungen / Modifizierungen von Normverfahren angeben)	Prüfbereich/ Einschränkung
	VDE 0276 Teil 603 DIN VDE 0276-603 HD 603 S1/A3	Starkstromkabel - Teil 603: Energieverteilungskabel mit Nennspannungen U_0/U 0,6/1 kV	<u>Einschränkung:</u> kein • Brennverhalten
	VDE 0276 Teil 605 DIN VDE 0276-605 HD 605 S2	Starkstromkabel - Teil 605: Ergänzende Prüfverfahren	<u>Einschränkung:</u> kein • Welterreißwiderstand • Druckprüfung • Bestimmung der Härte von elastomeren Isolierhüllen und Mänteln • Umweltbeständigkeit UV; Bewitterung; • Wickelprüfungen • Biegeprüfungen • Torsionsprüfungen • Abriebprüfung • Kerbkraftprüfung • Verzinkungsgüte • Steifigkeit • Thermogravimetrische Prüfung • Wasseraufnahme durch Kapazitätsmessung • Vernetzungsgrad von VPE • Durchlaufspannungsprüfu ng • Brandprüfungen
	VDE 0276 Teil 620 DIN VDE 0276-620 HD 620 S2	Starkstromkabel - Teil 620: Energieverteilungskabel mit extrudierter Isolierung für Nennspannungen U_0/U 3,6/6 kV bis 20,8/36 kV	<u>Einschränkung:</u> kein • Brennverhalten • Langzeitprüfung
	VDE 0276 Teil 626 + A1 DIN VDE 0276-626 + A1 HD 626 S1 + A1	Starkstromkabel - Teil 626: Isolierte Freileitungsseile für oberirdische Verteilungsnetze mit Nennspannung U_0/U (U_m) 0,6/1 (1,2) kV	<u>Einschränkung:</u> Bei HD 626 S1 + A1 nur Teil 4 F
	IEC 60840	Power cables with extruded insulation and their accessories for rated voltages above 30 kV ($U_m = 36$ kV) up to 150 kV (U_m = 170 kV) - Test methods and requirements	Ohne Brandprüfungen

Gültigkeitsdauer: 18.10.2011 bis 17.10.2016

ВЯРНО С
ОРИГИНАЛА

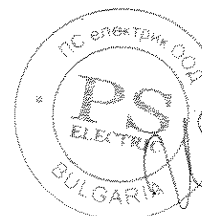



Anlage zur Akkreditierungsurkunde D-PL-15207-01-01

Deutsche
Akkreditierungsstelle

Fachbereich	Norm/ Hausverfahren/ Version	Titel der Norm oder des Hausverfahrens ¹ (ggf. Abweichungen / Modifizierungen von Normverfahren angeben)	Prüfbereich/ Einschränkung
Starkstrom- kabel- Garnituren	VDE 0278-393 DIN EN 50393	Prüfverfahren und Prüfanforderungen für die Garnituren von Verteilerkabeln mit einer Nennspannung von 0,6/1,0 (1,2) kV	
	VDE 0278 Teil 442 DIN EN 61442	Prüfverfahren für Starkstromkabelgarnituren mit einer Nennspannung von 6 kV ($U = 7,2$ kV) bis 36 kV ($U = 42$ kV) (IEC 61442:2005, modifiziert)	
	VDE 0278 Teil 629-1 DIN VDE 0278-629-1 HD 629.1 S2	Prüfanforderungen für Kabelgarnituren für Starkstromkabel mit einer Nennspannung von 3,6/6(7,2) kV bis 20,8/36(42) kV - Teil 1: Kabel mit extrudierter Kunststoffisolierung	
	VDE 0278 Teil 629-2 DIN VDE 0278-629-2 HD 629.2 S2	Prüfanforderungen für Kabelgarnituren für Starkstromkabel mit einer Nennspannung von 3,6/6(7,2) kV bis 20,8/36(42) kV - Teil 2: Kabel mit massegetränkter Papierisolierung	
	IEC 60502-1	Power cables with extruded insulation and their accessories for rated voltages from 1 kV ($U_m = 1.2$ kV) up to 30 kV ($U_m = 36$ kV) - Part 1: Cables for rated voltages of 1 kV ($U_m = 1.2$ kV) and 3 kV ($U_m = 3.6$ kV)	
	IEC 60502-2	Power cables with extruded insulation and their accessories for rated voltages from 1 kV ($U_m = 1.2$ kV) up to 30 kV ($U_m = 36$ kV) - Part 2: Cables for rated voltages from 6 kV ($U_m = 7.2$ kV) up to 30 kV ($U_m = 36$ kV)	
	IEC 60502-4	Power cables with extruded insulation and their accessories for rated voltages from 1 kV ($U_m = 1.2$ kV) up to 30 kV ($U_m = 36$ kV) - Part 4: Test requirements on accessories for cables with rated voltages from 6 kV ($U_m = 7,2$ kV) up to 30 kV ($U_m = 36$ kV)	
Press- und Schraub- verbinder	zVDE 0220 Teil 1 zDIN VDE 0220-1	Bestimmungen für lösbare Kabelklemmen in Starkstrom-Kabelanlagen bis 1000 V	
	zVDE 0220 Teil 2 zDIN VDE 0220-2	Bestimmungen für Pressverbinder in Starkstrom-Kabelanlagen	
	VDE 0220 Teil 100 DIN EN 61238-1 IEC 61238-1	Pressverbinder und Schraubverbinder für Starkstromkabel für Nennspannungen bis einschließlich 36 kV ($U_m = 42$ kV) - Teil 1: Prüfverfahren und Anforderungen	
Isolierstoffe	VDE 0370 Teil 2 DIN EN 60422 IEC 60422	Richtlinie zur Überwachung und Wartung von Isolierölen auf Mineralölbasis in elektrischen Betriebsmitteln (IEC 60422:2005)	

Gültigkeitsdauer: 18.10.2011 bis 17.10.2016

ВЯРНО С
ОРИГИНАЛА

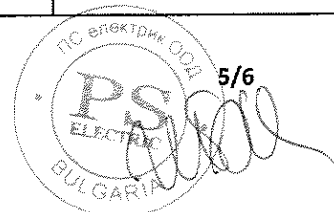

Anlage zur Akkreditierungsurkunde D-PL-15207-01-01

Fachbereich	Norm/ Hausverfahren/ Version	Titel der Norm oder des Hausverfahrens ¹ (ggf. Abweichungen / Modifizierungen von Normverfahren angeben)	Prüfbereich/ Einschränkung
	VDE 0370 Teil 5 DIN EN 60156 EN 60156 IEC 60156	Isolierflüssigkeiten Bestimmung der Durchschlagsspannung bei Netzfrequenz Prüfverfahren	
	VDE 0370 Teil 20 DIN EN 60814 IEC 60814	Isolierflüssigkeiten Ölimprägniertes Papier und ölimprägnierter Pressspan; Bestimmung von Wasser mit automatischer Karl-Fischer- Titration	
	VDE 0380 Teil 2 DIN EN 60247 IEC 60247	Isolierflüssigkeiten - Messung der Permittivitätszahl, des dielektrischen Verlustfaktors ($\tan \delta$) und des spezifischen Gleichstrom- Widerstandes	
	VDE 0370-31 DIN EN 62021-1 IEC 62021-1	Isolierflüssigkeiten - Bestimmung des Säuregehaltes - Teil 1: Automatische potentiometrische Titration	
	VDE 0278-631-1 DIN VDE 0278-631- 1 HD 631.1 S2	Kabel und isolierte Leitungen - Garnituren - Materialcharakterisierung - Teil 1: Fingerprint- und Typprüfungen für Reaktionsharzmassen	<u>Einschränkung:</u> keine • Volumenschwindung

ВЯРНО С
ОРИГИНАЛА

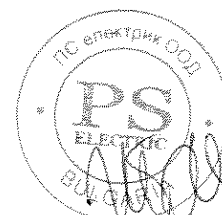

Gültigkeitsdauer: 18.10.2011 bis 17.10.2016

„ПС електрик“ ООД

ДЕКЛАРАЦИЯ ЗА СЪОТВЕТСТВИЕ

Долуподписаният Божидар Павлов Маринов, в качеството си на
Управител на „ПС електрик“ ООД, град Шумен, бул. „Мадара“ № 12,

ДЕКЛАРИРАМ

На собствена отговорност, че продуктът: **Щепселен кабелен адаптор
Euromold K158 LR**, произведен от: **Nexans Network Solutions NV**, за който
се отнася тази декларация, отговаря на приложимите български и
международни стандарти или еквиваленти и на техните валидни изменения и
поправки:

БДС HD 629.1 S2: 2006 Изисквания за изпитване на аксесоари за използване
със силови кабели с обявено напрежение от 3,6/6(7.2) kV до 20,8/36(42) kV.

Част 1: Кабели с екструдирана изолация;

БДС HD 629.1 S2: 2006/A1: 2008 Изисквания за изпитване на аксесоари за
използване със силови кабели с обявено напрежение от 3,6/6(7.2) kV до
20,8/36(42) kV. Част 1: Кабели с екструдирана изолация;

БДС EN 50181:2001 Прходни изводи щепселен тип над 1kV до 36kV и от
250A до 31,5kA за съоръжения, различни от маслени трансформатори;

БДС HD 620 S2: 2010 Разпределителни кабели с екструдирана изолация за
обявено напрежение от 3,6/6(7.2) kV до 20,8/36(42) kV

Декларирам, че ми е известна отговорността, която нося по член 313 от НК

03.08.2018 г.

На основание чл. 2
от ЗЗЛД

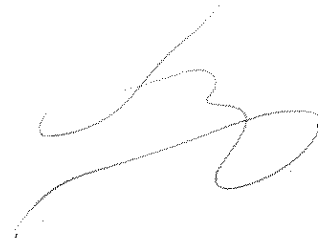

„ПС електрик“ ООД

ДЕКЛАРАЦИЯ ЗА СЪОТВЕТСТВИЕ

Долуподписаният Божидар Павлов Маринов, в качеството си на
Управител на „ПС електрик“ ООД, град Шумен, бул. „Мадара“ № 12,

ДЕКЛАРИРАМ

На собствена отговорност, че продуктът: **Щепселен кабелен адаптор
Euromold K430ТВ**, произведен от: **Nexans Network Solutions NV**, за който се
отнася тази декларация, отговаря на приложимите български и международни
стандарти или еквиваленти и на техните валидни изменения и поправки:

БДС HD 629.1 S2: 2006 Изисквания за изпитване на аксесоари за използване
със силови кабели с обявено напрежение от 3,6/6(7.2) kV до 20,8/36(42) kV.

Част 1: Кабели с екструдирана изолация;

БДС HD 629.1 S2: 2006/A1: 2008 Изисквания за изпитване на аксесоари за
използване със силови кабели с обявено напрежение от 3,6/6(7.2) kV до
20,8/36(42) kV. Част 1: Кабели с екструдирана изолация;

БДС EN 50181:2001 Прходни изводи щепселен тип над 1kV до 36kV и от
250A до 31,5kA за съоръжения, различни от маслени трансформатори;

БДС HD 620 S2: 2010 Разпределителни кабели с екструдирана изолация за
обявено напрежение от 3,6/6(7.2) kV до 20,8/36(42) kV

Декларирам, че ми е известна отговорността, която нося по член 313 от НК

03.08.2018 г.

На основание чл. 2
от ЗЗЛД



ВНИМАНИЕ: Да се прочетат инструкциите преди началото на монтажа.

Инструкции за монтаж на разглобяем L-образен конектор - тип А за кабели с екран от медни телове

(K)158LR

За размери FG - GA - GAB - GH

Нужните компоненти за монтаж на конектора:

1 x L-образно тяло на конектора

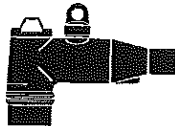

1 x Щифтов контакт + ключе



1 x Кабелен контакт (обувка)



1 x Осигурителна скоба



1 x 11TL адаптор (опция за кабели с ограничено екструдирани полупроводим слой)

- Силиконова смазка

- Инструкции за монтаж и схема на каб. разделка

Други компоненти, зависещи от приложението (само по заявка):

- Водохерметизиращ мастик, тип MWS, само за открит монтаж

ИЗБЕРЕТЕ СЪГЛАСНО ТИПА НА КАБЕЛА

A

Ограничено екстр.
полупроводим слой

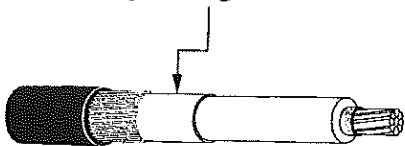

Отиди на стр.2

B

Свободно екстр.
полупроводим слой

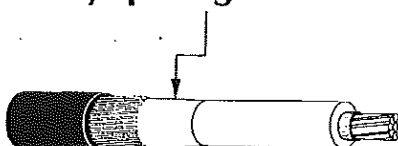

Отиди на стр.4

C

Полупроводим слой
от графит

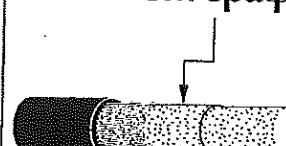

Отиди на стр.6

ВЪРНО С
ОРИГИНАЛА

90006E-R/5

Този продукт трябва да се монтира от компетентен работник, който има разрешение да работи с висиковолтова екипировка. Тези инструкции не са замислени като заместител на адекватния опит по условията на безопасност. Тези инструкции не заместват осигуряването за всеки възможен случай. Неспазването им може да доведе до увреждане на продукта и до сериозни и фатални загуби.
ВАЖНО: Кабелът и съедин. апаратура трябва да се изключат и обозначат преди началото на монтажа.

PS ELECTRIC BULGARIA

A

С ограничено екструдиран полупр. слой

КАБЕЛНА РАЗДЕЛКА

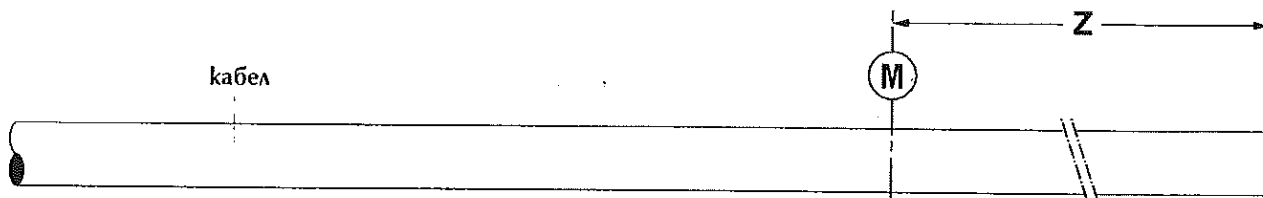

1. Поставяне на кабела в приблизително окончателно положение спрямо проходния изолатор.
2. Разстоянието "Z" между края на кабела и оста "М" на проходния изолатор трябва да бъде достатъчно дълго, за да се свърже медния екран на заземителната с-ма на конектора с тази на екипировката (съоръжението).

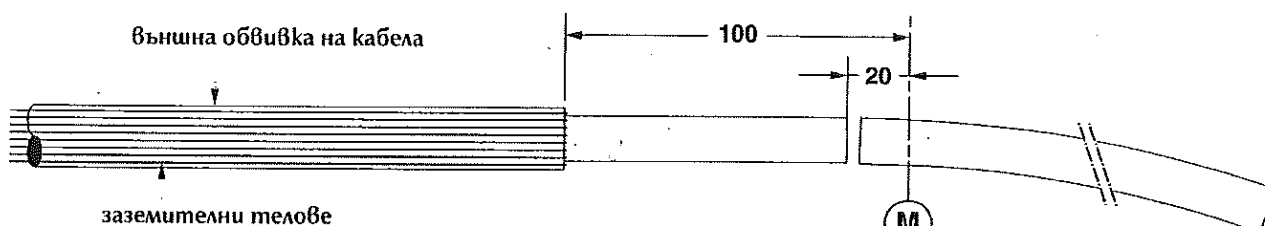
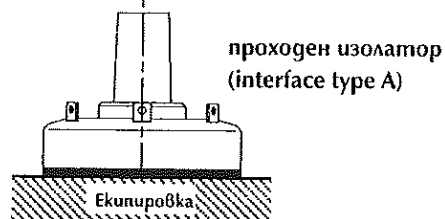

3. Отстраняване на външната обвивка на кабела от края му до точка, която е на 100 mm от оста "М" на прох. изолатор. **ДА НЕ СЕ РЕЖАТ ТЕЛОВЕТЕ ОТ ЕКРАНА.**
4. Огъване теловите на екрана назад покрай външн. обвивка.
5. Отрязване на кабела на 20 mm от оста "М" на проходния изолатор.

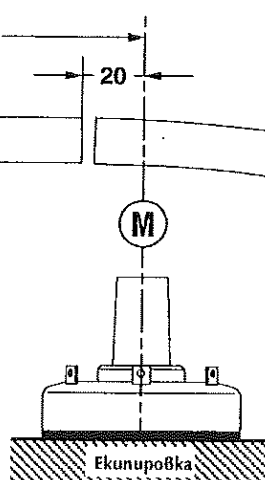

КЕРБОВАНЕ НА КАБЕЛНИЯ КОНТАКТ

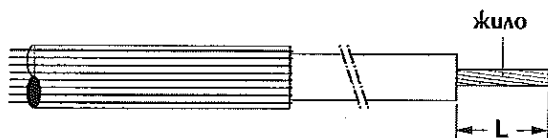

1. Отстраняване на осн. изолацията от жилото на разстояние "L" от края на кабела:
 - за медно жило: $L = 40$ mm;
 - за алуминиево жило: $L = 50$ mm.
2. При алуминиево жило: преди монтирането на каб. контакт, жилото се почиства с телена четка.

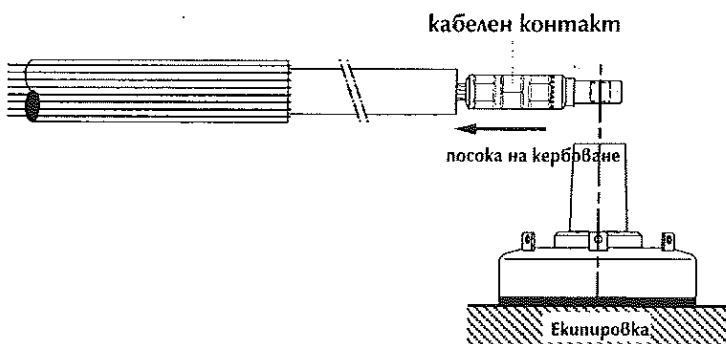

**ВЯРНО С
ОРИГИНАЛА**

3. Поставяне на каб. контакт, така че отворът му да е съосен с отвора на проходния изолатор.
4. Пресоване на кабелния контакт. **СТАРАТЕЛНО ИЗБЪРСВАНЕ.**

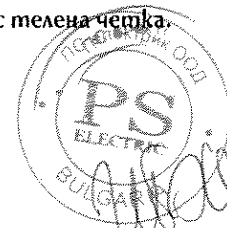

ПОДГОТОВКА НА КАБЕЛА И МОНТАЖ НА 11TL-АДАПТОРА (ако се изисква)

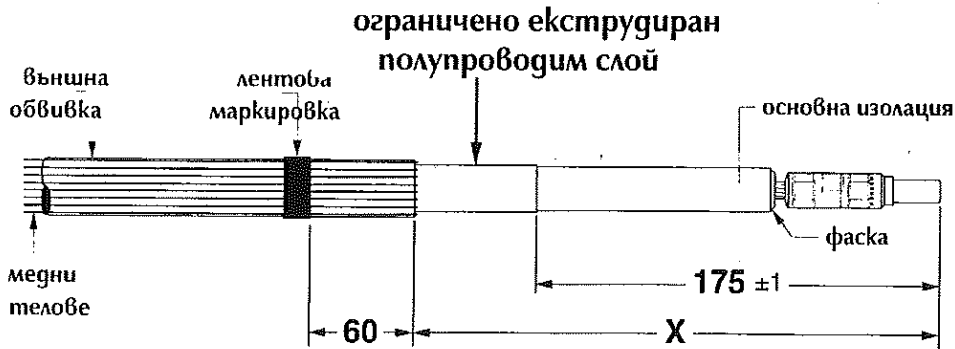

Използван адаптор	X (mm)
не	205
11TL	230

1. Отстраняване на външната обвивка на кабела до точка, която е на "X" mm от края на кабелния контакт.
2. Ако се използва адаптор 11TL, се поставя лентова маркировка на 60 mm от края на външната обвивка.
3. Отстраняване на полупроводимия слой на разстояние 175 ± 1 mm от края на кабелния контакт.
4. Направа на малка фаска на края на основната изолация (2 mm max).
5. Ако не се използва адаптор 11 TL се продължава на стр. 8: "Монтаж на конектора".

6. ЗА ОТКРИТ МОНТАЖ

Поставяне един слой водохерметизиращ мастик (тип MWS) върху външн. обвивка наравно с края ѝ (min 25 mm шир.). Отново огъване на теловете назад покрай външната обвивка като се натикват в херметизиращия мастик.

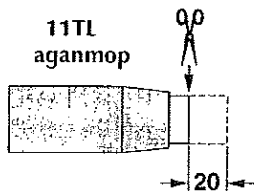
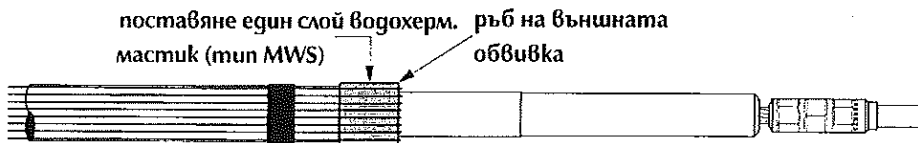

7. Отрязване пръстена на адаптора 11TL на разстояние 20 mm.

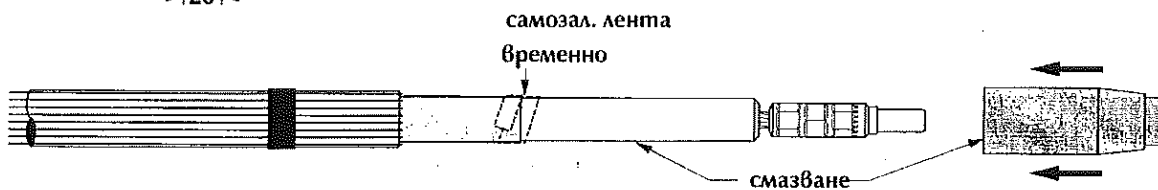

8. Като помощ при монтажа на адаптора се препоръчва да се навият един или два слоя самозалепваща се лента застъпващо върху края на полупроводимия слой.
9. Да се намаже* основната изолация и вътрешността на адаптора.

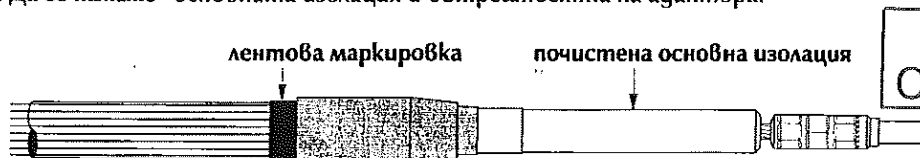

10. Плъзгане на адаптора над основната изолация, докато се изравни с лентовата маркировка.
11. Отстраняване на самозалепващата се лента, използвана в стъпка 8.
ВНИМАТЕЛНО ПОЧИСТВАНЕ НА ОСНОВНАТА ИЗОЛАЦИЯ, ИЗПОЛЗВАЙКИ ПОЧИСТВАЩИТЕ МАТЕРИАЛИ.
Избърсването винаги да става по посока теловете на екрана.

ПРЕМИНАВАНЕ НА СТРАНИЦА 8 ЗА МОНТАЖ НА КОНЕКТОРА

* Да се използва само поставената в комплекта силиконова смазка

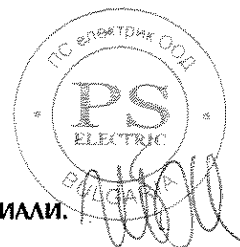

B

Свободно екструдирани полупров. слой

КАБЕЛНА РАЗДЕЛКА

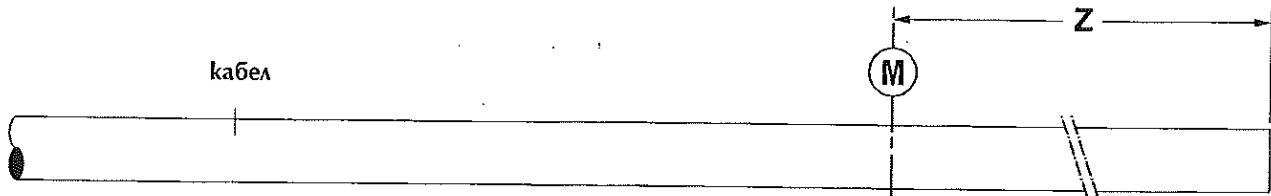

1. Поставяне на кабела в приблизително окончателно положение спрямо проходния изолатор.
2. Разстоянието "Z" между края на кабела и оста "М" на проходния изолатор трябва да бъде достатъчно дълго, за да се свърже медния екран на заземителната с-ма на конектора с тази на екипировката (съоръжението).

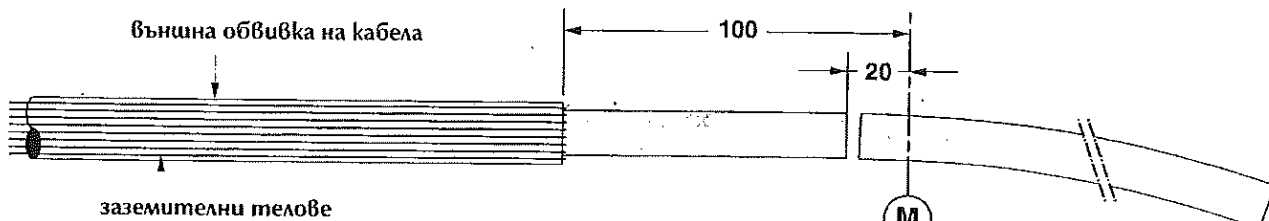
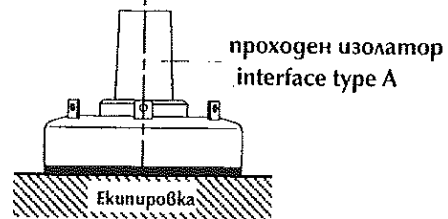

3. Отстраняване на външната обвивка на кабела от края му до точка, която е на 100 mm от оста "М" на прох. изолатор. **ДА НЕ СЕ РЕЖАТ ТЕЛОВЕТЕ ОТ ЕКРАНА.**
4. Огъване теловете на екрана назад покрай външн. обвивка.
5. Отрязване на кабела на 20 mm от оста "М" на проходния изолатор.

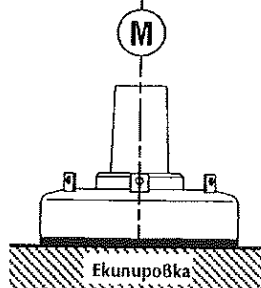

КЕРБОВАНЕ НА КАБЕЛНИЯ КОНТАКТ

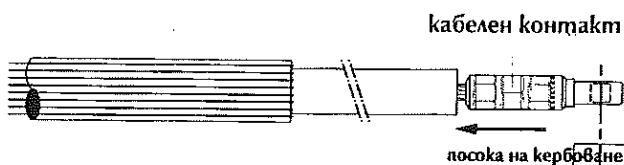
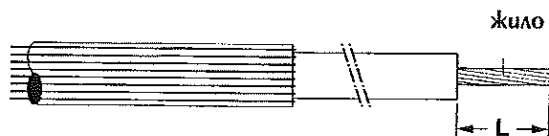

1. Отстраняване на осн. изолацията от жилото на разстояние "L" от края на кабела:
 - за медно жило: $L = 40$ mm;
 - за алуминиево жило: $L = 50$ mm.
2. При алуминиево жило: преди монтирането на каб. контакт, жилото се почиства с телена четка.

3. Поставяне на каб. контакт, така че отворът му да е съосен с отвора на проходния изолатор.
4. Пресоване на кабелния контакт. **СТАРАТЕЛНО ИЗБЪРСВАНЕ.**

**ВЯРНО С
ОРИГИНАЛА**

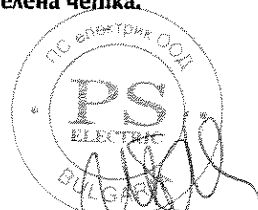

ПОДГОТОВКА НА КАБЕЛА И МОНТАЖ НА 11 TL-АДАПТОРА

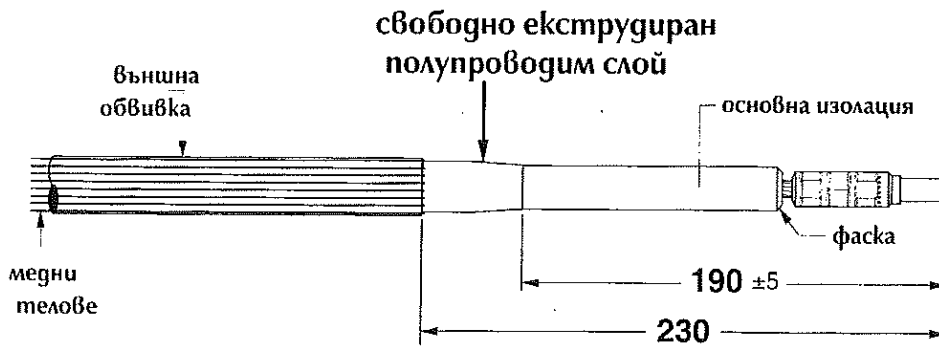

1. Отстраняване на външната обвивка на кабела до точка, която е на 230 mm от края на кабелния контакт.
2. Отстраняване на полупроводимия слой на разстояние 190 ± 5 mm от края на кабелния контакт.
3. Направа на малка фаска на края на основната изолация (2 mm max).

4. ЗА ОТКРИТ МОНТАЖ

Поставяне един слой водохерметизиращ мастик (тип MWS) върху външн. обвивка наравно с края ѝ (min 25 mm шир.)
Отново огъване на телове назад покрай външната обвивка като се натикват в херметизиращия мастик.

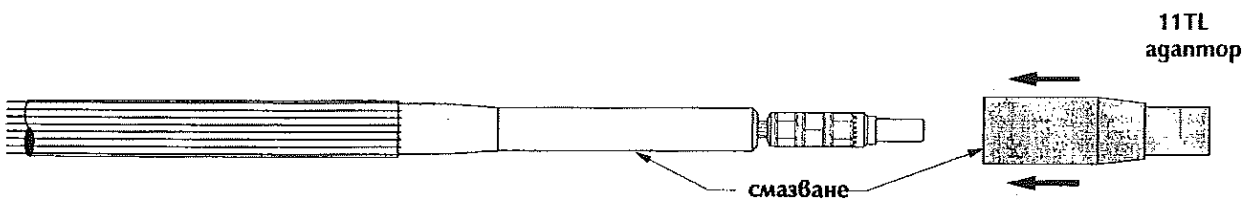
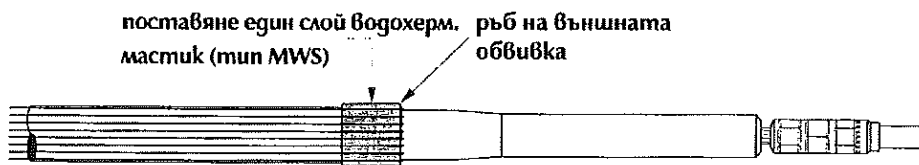

5. Да се намаже* основната изолация и вътрешността на адаптора.

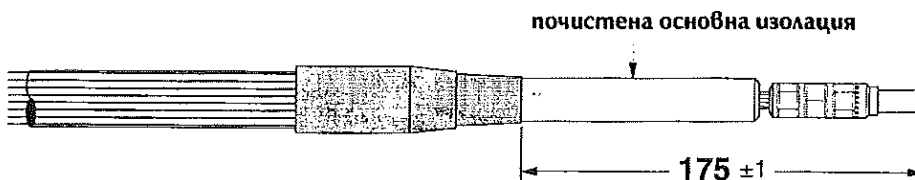

6. Плъзгане на адаптора над основната изолация до точка 175 ± 1 mm от края на кабелния контакт.
ВНИМАТЕЛНО ПОЧИСТВАНЕ НА ОСНОВНАТА ИЗОЛАЦИЯ, ИЗПОЛЗВАЙКИ ПОДХОДЯЩ РАЗТВОРИТЕЛ.
Избърсването винаги да става по посока телове на екрана.

ПРЕМИНАВАНЕ НА СТРАНИЦА 8 ЗА МОНТАЖ НА КОНЕКТОРА

* Да се използва само поставената в комплекта силиконова смазка

ВЯРНО С
ОРИГИНАЛА

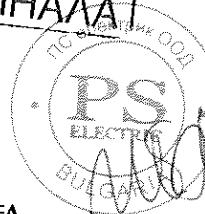



Екран от графитна обмазка

КАБЕЛНА РАЗДЕЛКА

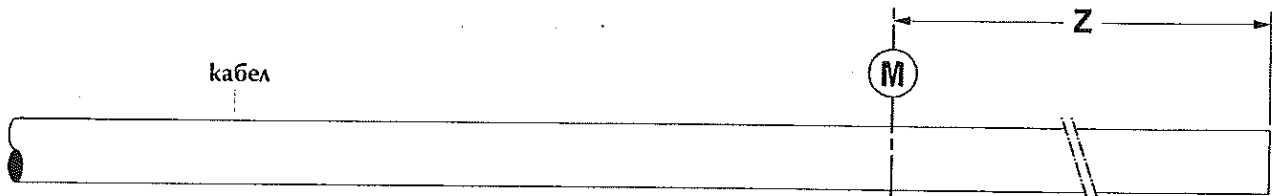

1. Поставяне на кабела в приблизително окончателно положение спрямо проходния изолатор.
2. Разстоянието "Z" между края на кабела и оста "М" на проходния изолатор трябва да бъде достатъчно дълго, за да се свърже медния екран на заземителната с ма на конектора с тази на екипировката (съоръжението).

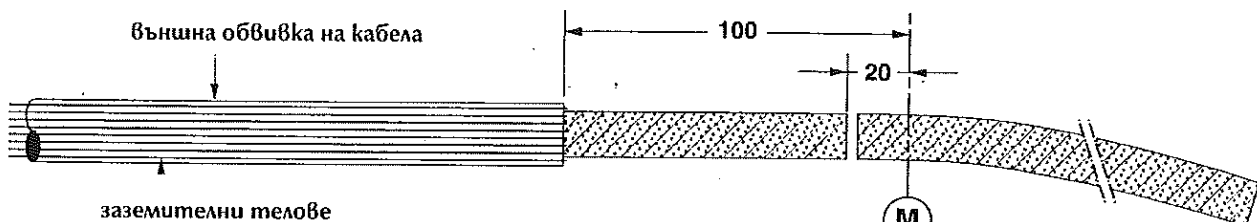
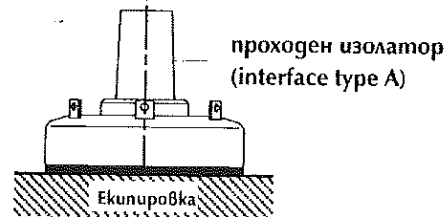

3. Отстраняване на външната обвивка на кабела от края му до точка, която е на 100 mm от оста "М" на прох. изолатор.
ДА НЕ СЕ РЕЖАТ ТЕЛОВЕТЕ ОТ ЕКРАНА.
4. Огъване теловите на екрана назад покрай външната обвивка.
5. Отрязване на кабела на 20 mm от оста "М" на проходния изолатор.

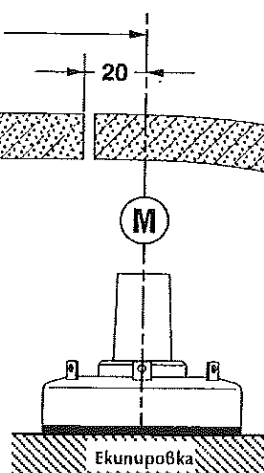

КЕРБОВАНЕ НА КАБЕЛНИЯ КОНТАКТ

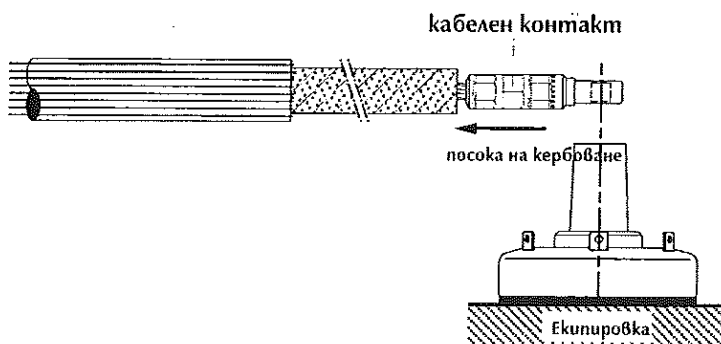
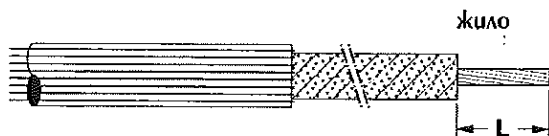

1. Отстраняване на осн. изолация от жилото на разстояние "L" от края на кабела:
 - за медно жило: $L = 40$ mm;
 - за алуминиево жило: $L = 50$ mm.
2. При алуминиево жило: преди монтирането на каб. контакт, жилото се почиства с телена четка.

**ВЯРНО С
ОРИГИНАЛА**



3. Поставяне на каб. контакт, така че отворът му да е съосен с отвора на проходния изолатор.
4. Пресоване на кабелния контакт.
СТАРАТЕЛНО ИЗБЪРСВАНЕ.

ПОДГОТОВКА НА КАБЕЛА И МОНТАЖ НА 11 TL-АДАПТОРА

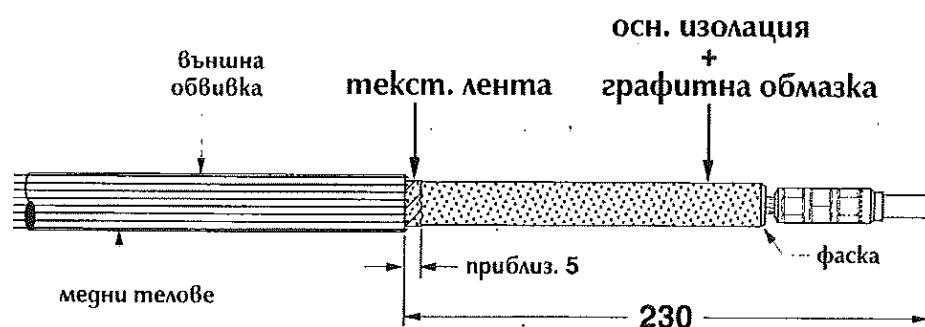

1. Отстраняване на външната обвивка на кабела до точка, която е на 230 mm от края на кабелния контакт.
2. Отстраняване на текстилната лента на разстояние приблизително 5 mm от края на външната обвивка.
НА ТОЗИ ЕТАП ДА НЕ СЕ ОТСТРАНЯВА ГРАФИТНАТА ОБМАЗКА.
3. Направа на малка фаска на края на основната изолация (2 mm max).

4. ЗА ОТКРИТ МОНТАЖ

Поставяне един слой водохерметизиращ мастик (тип MWS) върху външн. обвивка наравно с края ѝ (min 25 mm шир.).
Отново огъване на теловете назад покрай външната обвивка като се натикват в херметизиращия мастик.

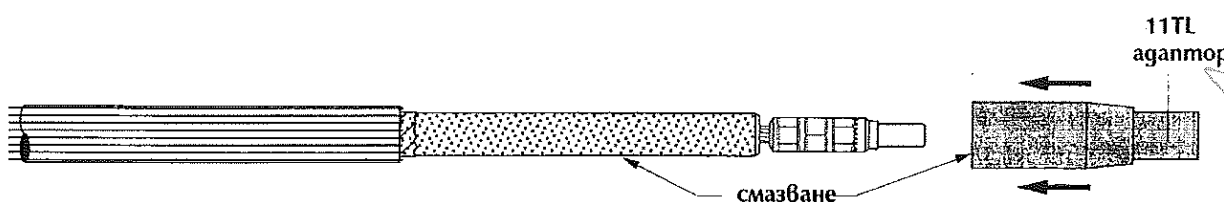
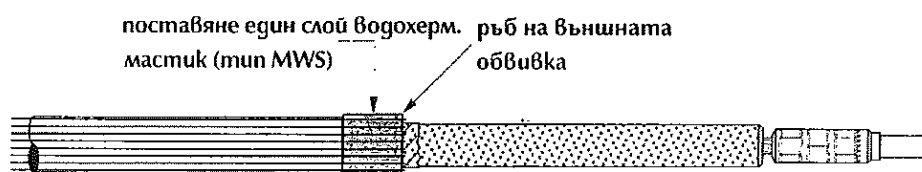

5. Да се намаже* основната изолация и вътрешността на адаптора.

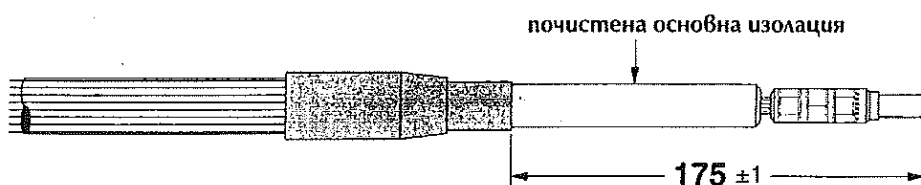

ВЯРНО С
ОРИГИНАЛА

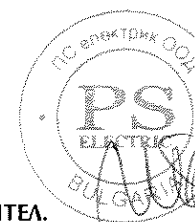

6. Плъзгане на адаптора над основната изолация до точка 175 ± 1 mm от края на кабелния контакт.
ВНИМАТЕЛНО ПОЧИСТВАНЕ НА ГРАФИТНАТА ОБМАЗКА, ИЗПОЛЗВАЙКИ ПОДХОДЯЩ РАЗТВОРИТЕЛ.
Избърсването винаги да става по посока теловете на екрана.

* Да се използва само поставената в комплекта силиконова смазка.

A B C

Прилага се при всички кабели

МОНТАЖ НА КОНЕКТОРА И НА ЗАЗЕМИТЕЛНИЯ ЕКРАН

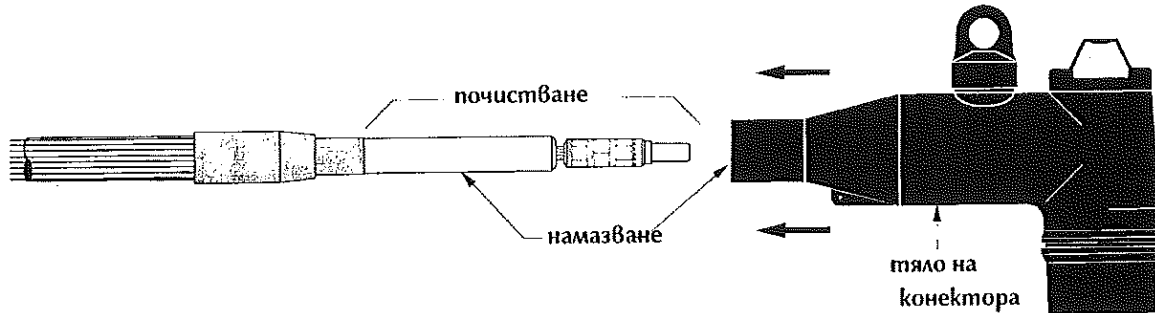

1. СТАРАТЕЛНО ПОЧИСТВАНЕ НА ОСНОВНАТА ИЗОЛАЦИЯ, ОТСТРАНЯВАЙКИ ВСИЧКИ ОСТАТЪЦИ ОТ ПОЛУПРОВОДИМИЯ СЛОЙ. Избърсването винаги да става по посока теловете на екрана.
2. Намазване* на основната изолация и вътрешната повърхнина на конектора.
3. Проверка на позиционирането на L-образния конектор спрямо отвора в ухото на кабелния контакт и тялото на конектора се плъзга спокойно по кабела, докато повече не може да се придвижи.

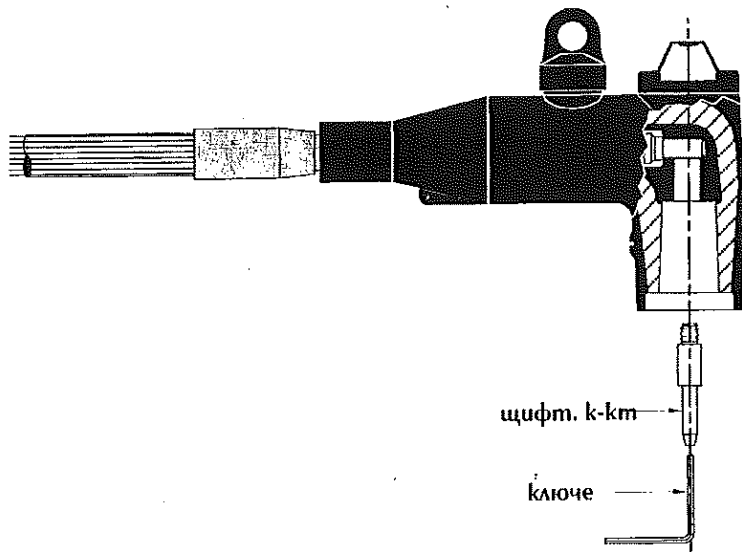

4. Поставяне с ръка на щифтовия контакт с резбата напред в съединителната част на конектора.
5. Завиване чрез шестстенното ключе от комплекта докато понататъшното навиване стане невъзможно.

Монтаж с 11TL-адаптор

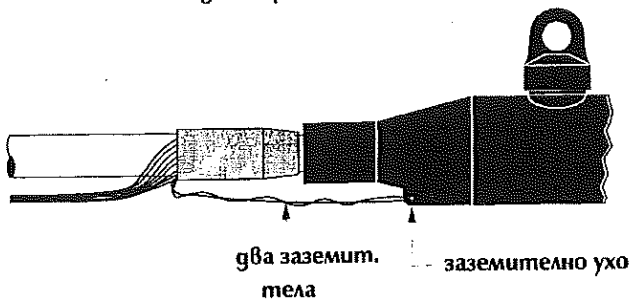

Монтаж без 11TL-адаптор

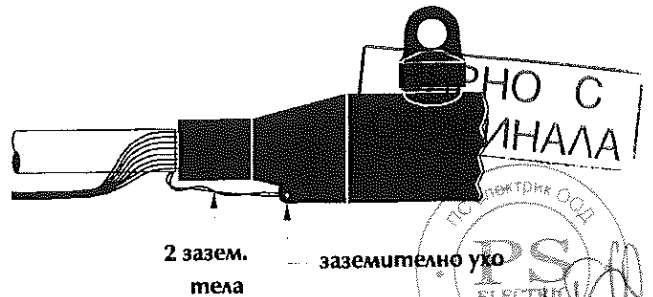

6. Свързване на заземит. екран на кабела чрез два от заземит. телове със зазем. ухо на конектора.

***Да се използва само поставената в комплекта силиконова смазка.**

МОНТАЖ НА КОНЕКТОРА КЪМ ПРОХОДНИЯ ИЗОЛАТОР

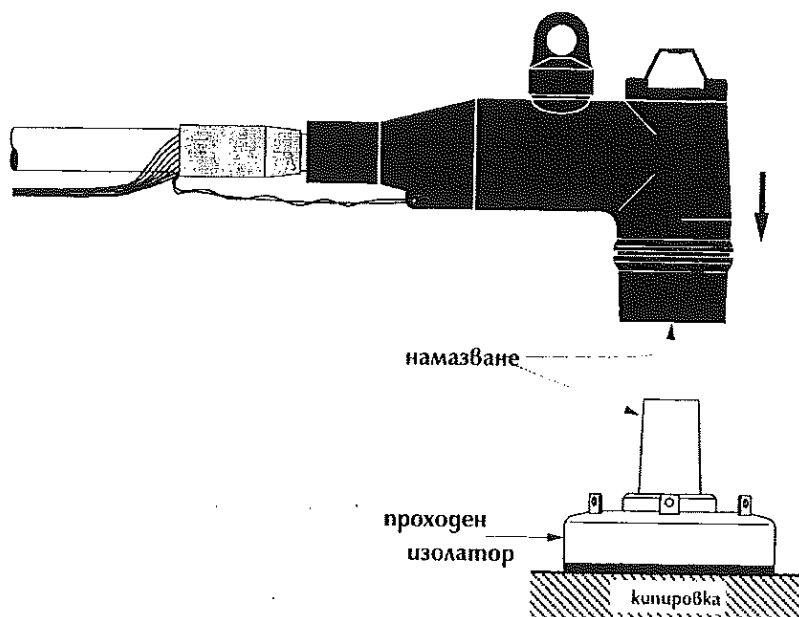

1. Почистване и намазване* вътрешната повърхнина на конектора и външната повърхнина на проходния изолатор.
2. Набутване на конектора върху проходния изолатор.

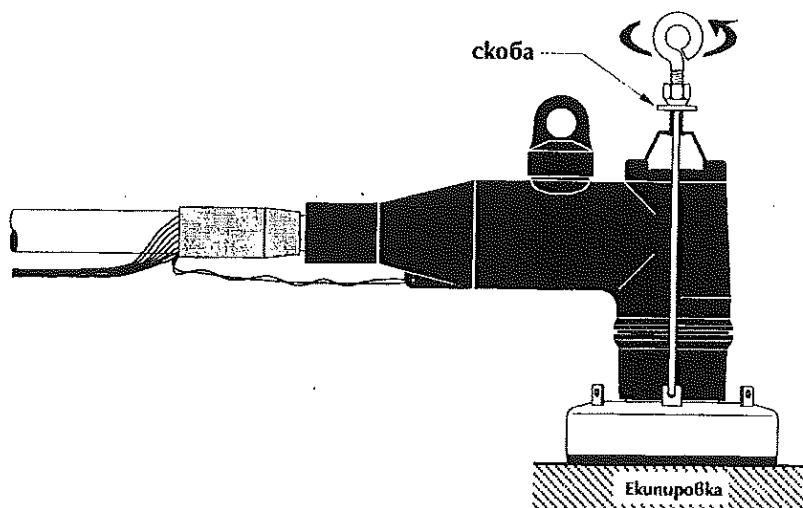

3. Поставяне на скобата в ушите на проходния изолатор.
 4. Позициониране на скобата и завиване на ухото-болт.
- ДА НЕ СЕ ПРИЛАГА ПРЕКАЛЕНА СИЛА ВЪРХУ L-КОНЕКТОРА.**

Нагласяване на контрагайката, така че ухото-болт сигурно да стои върху фиксатора. Контрагайката не позволява чрез ухото-болт да се прилага допълнително прекалено усилие върху конектора.

Щом веднъж е нагласена контрагайката, тя не трябва да се пренастройва при вадене на конектора.

*Да се използва само поставената в комплекта силиконова смазка.

ВЯРНО С
ОРИГИНАЛА

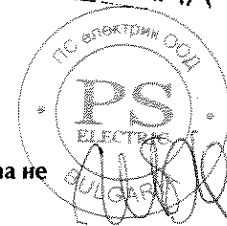

ЗАЗЕМЯВАНЕ НА ЕКРАНА И УКРЕПВАНЕ НА КАБЕЛА

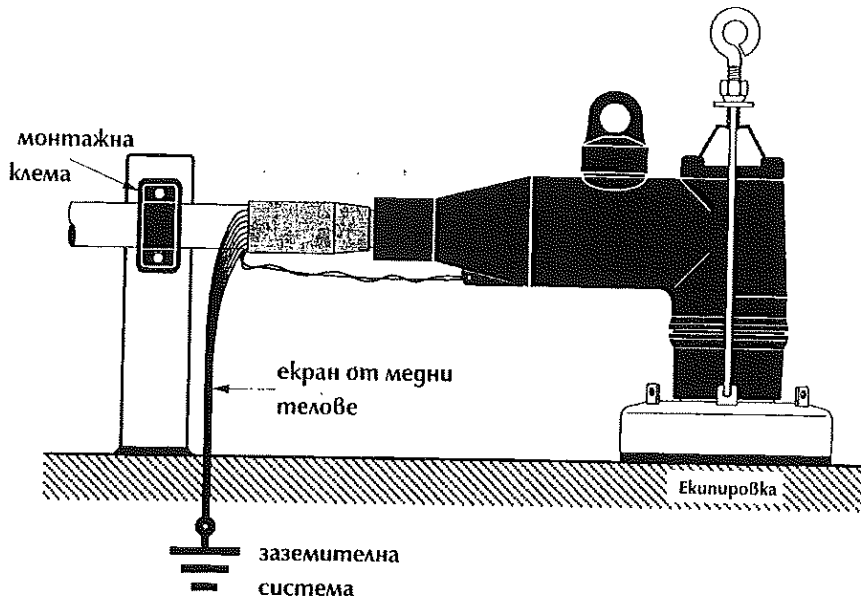

1. Извиване назад на теловете от екрана и оформянето им като "свинска опашка".
2. Свързване на теловете от екрана със заземителната система.

БЕЛЕЖКА:

Комбинацията конектор/проходен изолатор не би могла да носи цялото тегло на кабела.

Необходимо е да се укрепи кабела възможно най-близо до конектора.

ВАЖНИ БЕЛЕЖКИ:

- Никога да не се съединява или разединява конектора без да са инсталирани преди това неговите съставни части.
- Да не се използват хидрокарбонови масла и разреждители, защото разлагат EPDM гумата. В случай на замърсяване, повърхнините да се избърсват със сух парцал.

Euromold
a Nexans company

"МАКРИС-ГПХ" ООД
Промислена зона "Орион", ул. "3020" №34
1360 СОФИЯ, БЪЛГАРИЯ
тел.: + 359 (0)2/920 41 43, телефакс: + 359 (0)2/20 29 20

ВЯРНО С
ОРИГИНАЛА

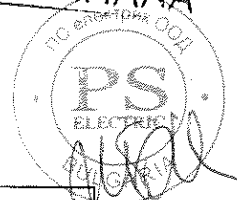

ВНИМАНИЕ: Да се прочетат инструкциите внимателно преди началото на монтажа.

Инструкции за монтаж на Т-образен щекер - тип С

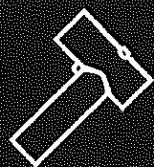











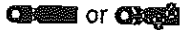

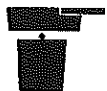
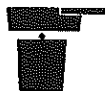
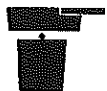

(К),(М)430ТВ/G

До 36 kV

Само за кабели с екран от медни телове и екструдирани полупроводим слой.
При кабели от друг вид моля да се обърнете към нашия представител.

Нужните компоненти за монтаж на щекера:

 3 x Тяло на щекера 430ТВ/G	 3 x Каб. редуцир 430СА-W	 3 x Клемна шпилка 430ТС	 or  3 x Пресова или винтова каб. обувка ТВС-Х или ТМВС-Х	 1 x Монт. дорник
 ИЛИ  3 x Осн. изолационна тапа + капачка 300ВІР - (до 24 kV)	 ИЛИ  3 x Осн. изолационна тапа + капачка 300ВІРА - (до 36 kV)	 3 x Зазем. каб. обувка	 Уплътн. мастик тип MWS	 Лепяща лента
 Ръкавици	 +  Сил. смазка + почистващи кърпи	 Инстр. за монтаж		

**ВЯРНО С
ОРИГИНАЛА**

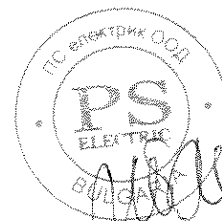

Euromold
a Nexans company

Този продукт трябва да се монтира от компетентен работник, който има разрешение да работи с високоволтова екипировка. Тези инструкции не са замислени като заместител на адекватния опит по условията на безопасност. Тези инструкции не заместват осигуряването за всеки възможен случай. Неспазването им може да доведе до увреждане на продукта и до сериозни и фатални загуби. **ВАЖНО:** Кабелът и уредбата трябва да се изключат и обезопасят преди началото на монтажа.

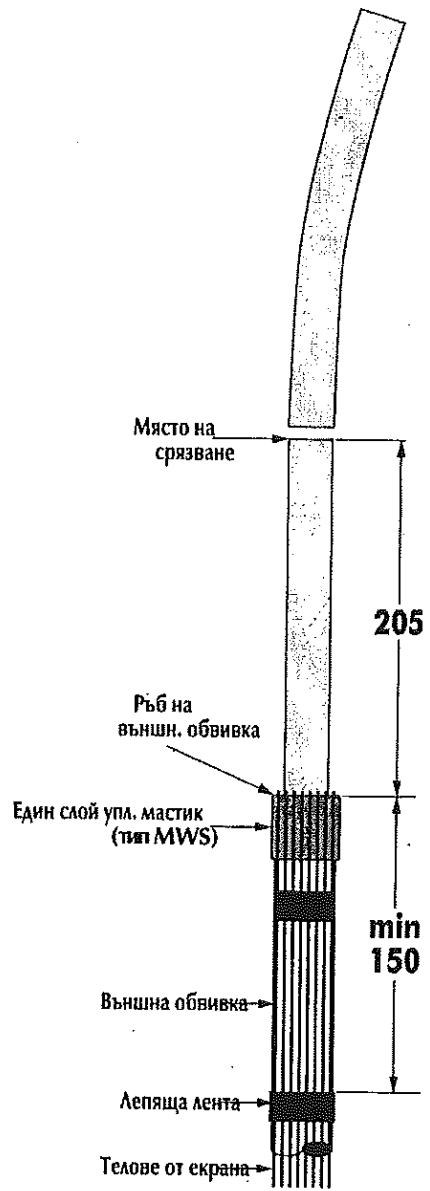
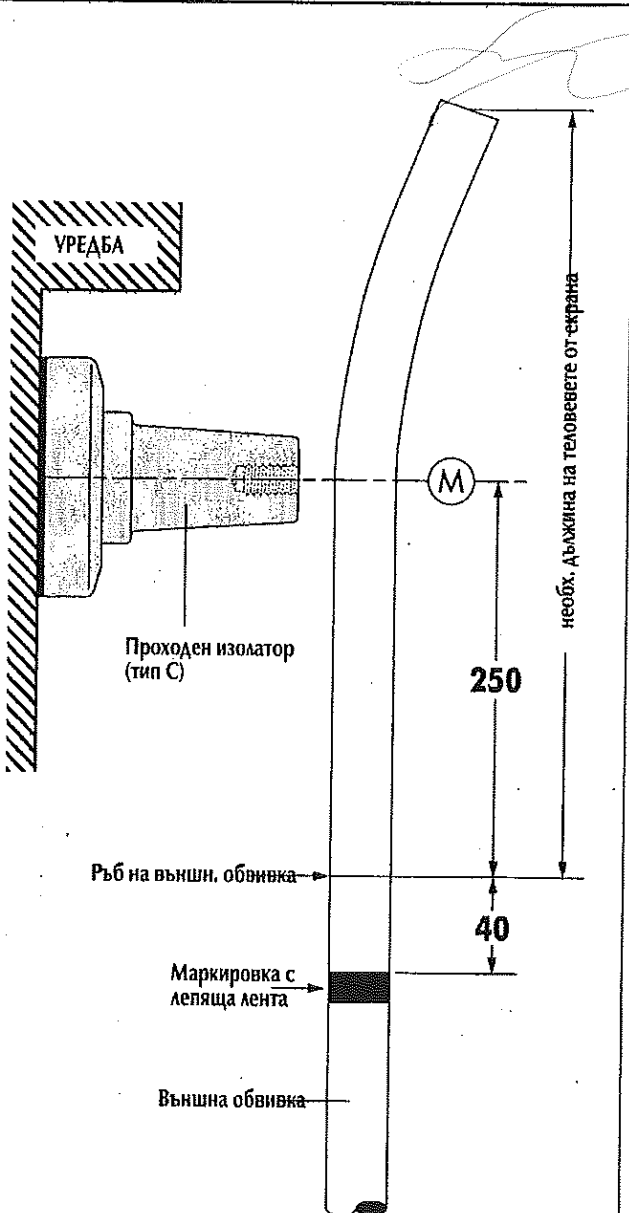

- 1 Поставя се кабела и се задържа до проходния изолатор, маркира се точка « М ».
- 2 Отстранява се външната обвивка на кабела на 250 mm от оста « М » на проходния изолатор.
- 3 Медните спирални ленти се отрязват късо при ръба на външната обвивка.
- 4 На разстояние 40 mm от ръба на външната обвивка се поставя маркировка от лепяща лента.

- 5 Полага се слой водохерметизиращ мастик (тип МWS) на ширина около 25 mm, върху външната обвивка наравно с ръба ѝ, като кабелът се обгърне. Телове на екрана се огъват назад покрай външната обвивка и на разстояние един от друг се притискат в слоя мастик.
- 6 На разстояние от min. 150 mm телове от екрана се фиксират временно с лепяща лента.
- 7 Кабелът се отрязва на разстояние 205 mm от ръба на външната обвивка.

ВЯРНО С
ОРИГИНАЛА

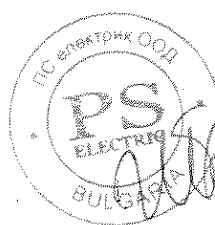

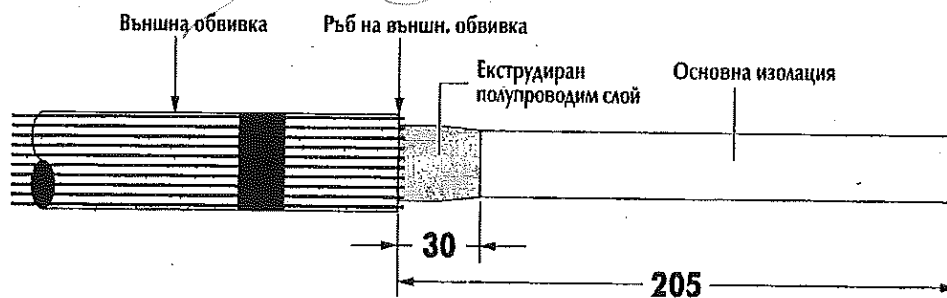

- 8 Снема се полупроводимия слой до 30 mm от ръба на външната обвивка с инструмент за кръгово снемане. (Преходният участък полупроводим слой / основна изолация да бъде плавен.)
- 9 В случай, че останат проводими участъци, внимателно да се отстранят от основната изолация.

А. Пресова каб. обувка (тип ТВС-Х)

В. Винтова кабелна обувка (тип ТМВС-Х)

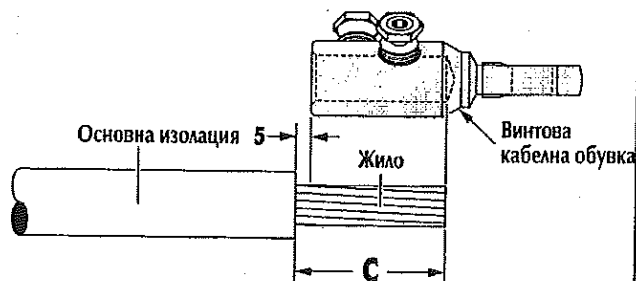
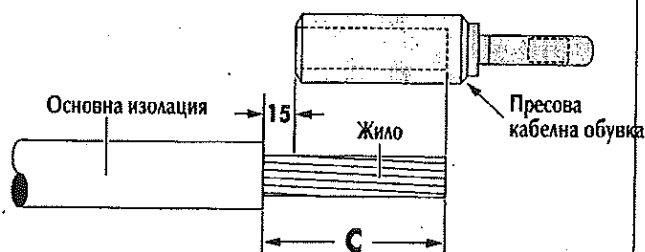

- 10 А. Пресова кабелна обувка:
Сваля се основната изолация на размер «С»
(«С» = Дълбочина на каб. обувка + 15 mm).

- 10 В. Винтова кабелна обувка:
Сваля се основната изолация на размер «С»
(«С» = Дълбочина на каб. обувка + 5 mm).

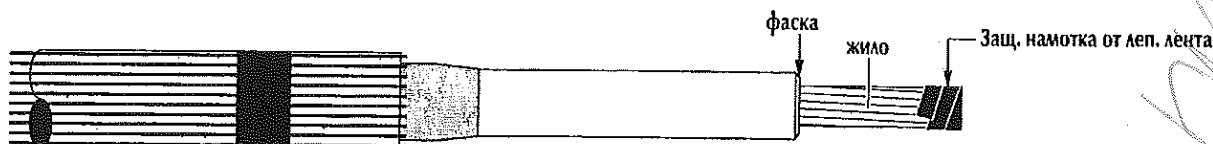

- 11 Прави се малка фаска на ръба на основната изолация.
- 12 Внимателно се почиства основната изолация с разтворител и бял парцал.
Посоката на почистването винаги е от края на кабелната обувка към теловете от екрана.
- 13 На края на жилото се намотава за защита лепяща лента.

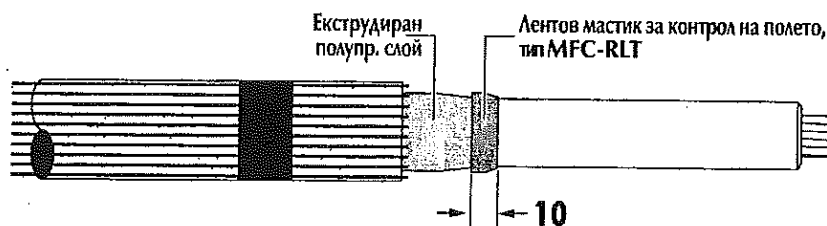

**ВЯРНО С
ОРИГИНАЛА**

Само за кабели 18/30 кV:

В средата на прехода полупроводим слой / основна изолация се поставя един слой лентов мастик за контрол на полето, тип MFC-RLT (ширина 10 mm).



За сечения на жилата от 35 mm² до 150 mm²

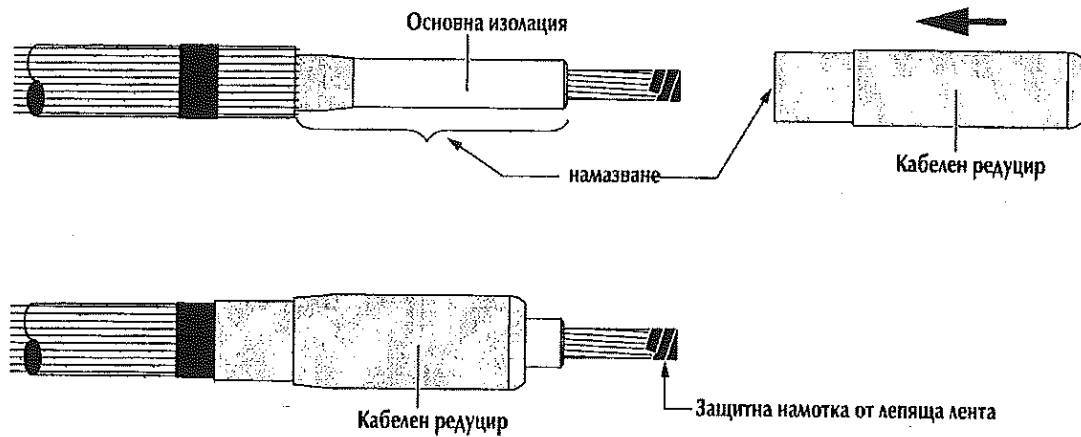

- 1 Намазват се кабелния редуцир отвътре, основната изолация и полупроводимия слой със силиконова смазка*.
- 2 Напъхва се кабелния редуцир върху кабела до маркировката.
- 3 Отстранява се защитната намотка от края на жилото.

ВЯРНО С
ОРИГИНАЛА

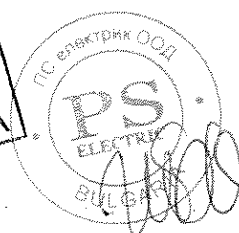

За сечения на жилата от 185 mm² до 300 mm²

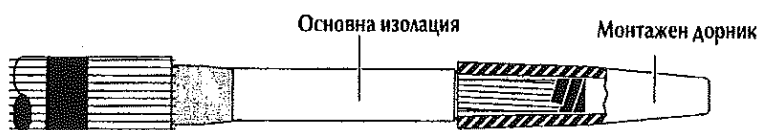

- 1 Напъхва се монтажния дорник върху жилото.

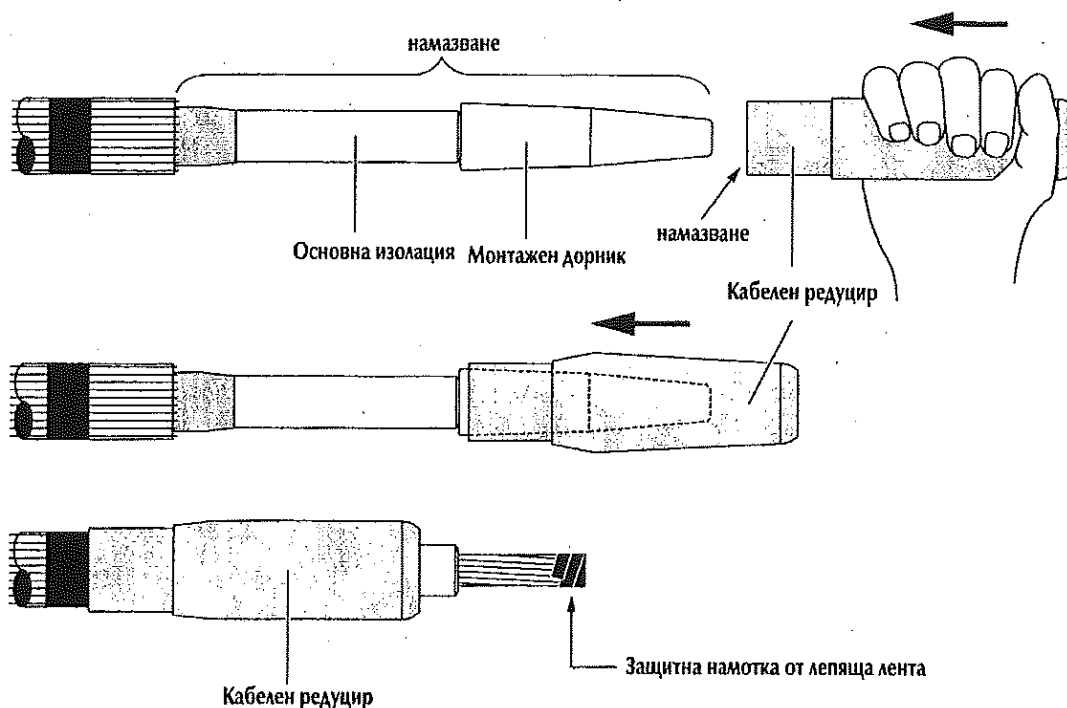

- 2 Монтажният дорник и основната изолация се почистват с разтворител и бяла кърпа.
 3 Намазват се кабелния редуцир отвътре, основната изолация и полупроводимия слой със силиконова смазка*.
 4 Напъхва се кабелния редуцир през монтажния дорник върху кабела до маркировката.
 Напъхването трябва да стане наведнъж, без спиране.
 5 Отстранява се защитната намотка от края на жилото.

A

Пресова каб. обувка (тип ТВС-Х)

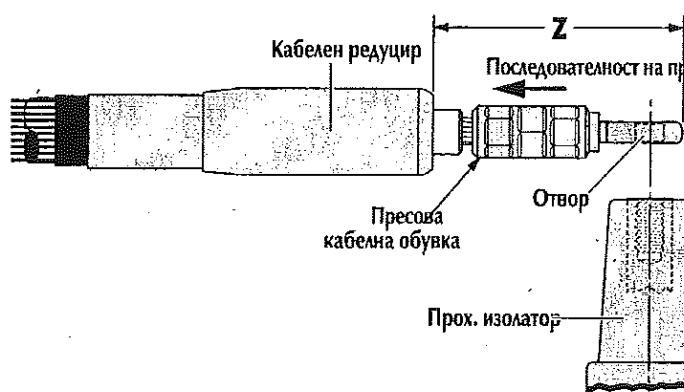

- 1 Напъхва се кабелната обувка върху жилото. Преди пресоването се нагласява оста на отвора на кабелната обувка да е успоредна с оста на проходния изолатор.
 2 Преди пресоването да се проконтролира раз-нието « Z ». Разстоянието « Z » преди прес. = 150 до 160 mm.
 3 Пресова се в посока към кабела (посоката на стрелката).
 4 Разстоянието « Z » след прес. = 155 до 165 mm.
 5 Отстраняват се евентуално образували се от пресоването чепълци и старателно се избърсва излязлата контактна смазка.

* ДА СЕ ИЗПОЛЗВА САМО СИЛИКОНОВАТА СМАЗКА ОТ КОМПЛЕКТА!

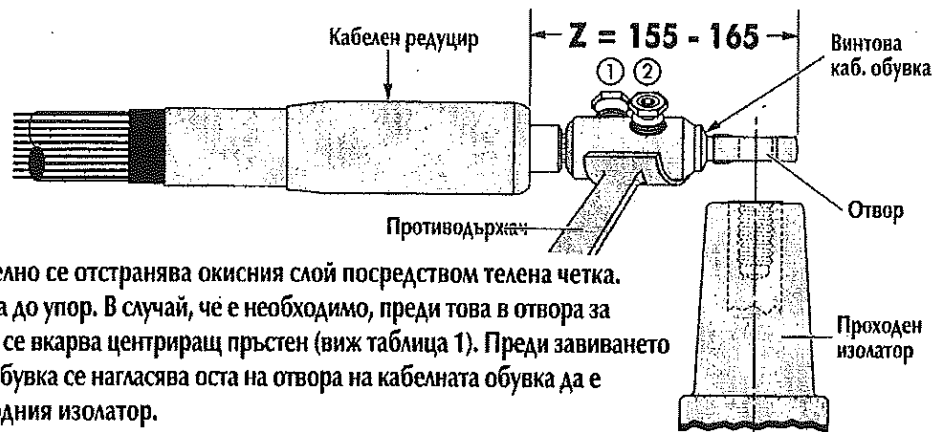
B**Винтова каб. обувка (тип TMBC-X)****Преди затягане**

- 1 При алум. жило предварително се отстранява окисния слой посредством телена четка.
- 2 Кабелната обувка се напъхва до упор. В случай, че е необходимо, преди това в отвора за жилото на кабелната обувка се вкарва центриращ пръстен (виж таблица 1). Преди завиването на винтовете на кабелната обувка се нагласява оста на отвора на кабелната обувка да е успоредна на оста на проходния изолатор.
- 3 Преди затягането на винтовете се проверява разстоянието Z . Разстоянието $Z = 155$ до 165 mm, Винтовата кабелна обувка трябва да се напъхва върху кабела до упор.
- 4 Винтовете се затягат равномерно на ръка. След това винтовете се затягат с инструмент (Виждат Таблица 2) (ако се използват други инструменти, то те трябва да са одобрени от Eurogold) редувайки се бавно и равномерно до скъсване (първо ①, след това ②). За осигуряване срещу превъртане при монтажа се използва противодържач.

TMBC-16.95-14-5-LV

Таблица 1





35 - 50 mm ²	70 - 95 mm ²
Сив  малък отвор	Жълт  голям отвор

Таблица 2

Al : 35 - 50 mm ² Cu : 35 - 50 mm ²	Al : 70 - 95 mm ² Cu : 70 - 95 mm ²
	 SW 6 L > 15 mm

TMBC-50.150-14-5-LV

Таблица 1



50 mm ²	70 - 95 mm ²	120 - 150 mm ²
Сив  малък отвор	Жълт  голям отвор	не е необходим центр. пръстен

Таблица 2

Al : 50 - 120 mm ² Cu : 50 - 95 mm ²	Al : 150 mm ² Cu : 120 mm ²
	 SW 6 L > 15 mm

TMBC-95.240-14-5-LV

Таблица 1



95 mm ²	120 - 150 mm ²	185 - 240 mm ²
Червен  малък отвор	Кафяв  голям отвор	не е необходим центр. пръстен

Таблица 2

Al : 95 - 185 mm ² Cu : 95 - 150 mm ²	Al : 240 mm ² Cu : 185 - 240 mm ²
	 SW 6 L > 19 mm

TMBC-120.300-12-5

Таблица 1



120 - 150 mm ²	185 - 300 mm ²
Син  малък отвор	не е необходим центр. пръстен

Таблица 2

Al : 120 - 240 mm ² Cu : 120 - 240 mm ²	Al : 300 mm ² Cu : 300 mm ²
	 SW 6 L > 19 mm

След затягане

- 5 След затягането на винтовете се отстраняват евентуално появили се чепльци и старателно се избърсва излязлата контактна смазка.
- 6 Разстоянието Z nach dem Verschrauben = 155 до 165 mm.

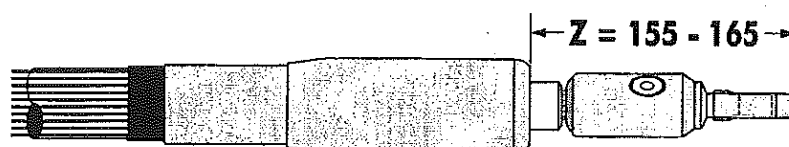
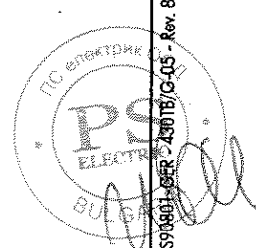
ВАРНО С
ОРИГИНАЛА

19/06/2018 PS ELEKTRIK BULGARIA Rev. 8

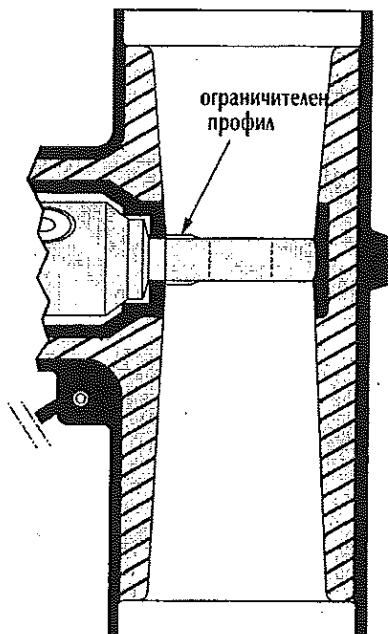
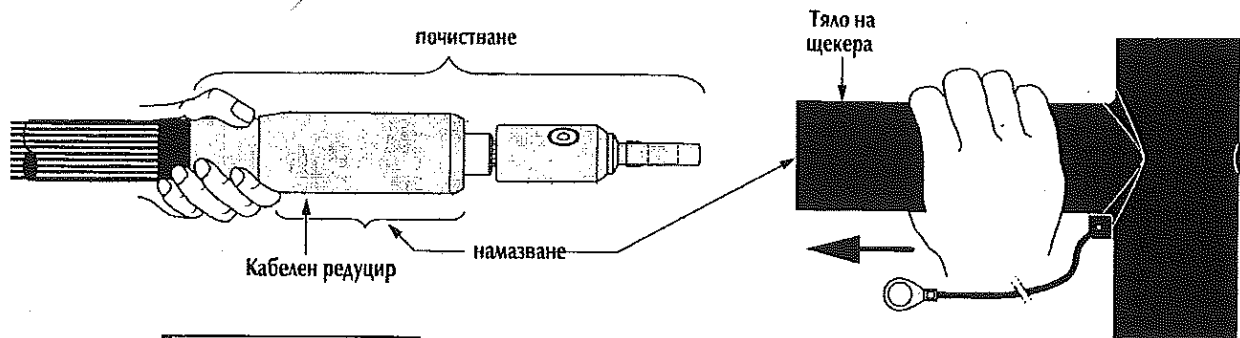

- 1 Кабелът, кабелната обувка, кабелният редуцир и щекерът се проверяват и ако е необходимо внимателно се почистват.
- 2 Кабелният редуцир и тялото на щекера отвътре се намазват със силиконовата смазка* от комплекта.
- 3 Тялото на щекера се напъхва до упор, като при това по-дългата страна трябва да сочи към извода за присъединяване. По време на напъхването кабелният накрайник се държи здраво с едната ръка в позицията си.

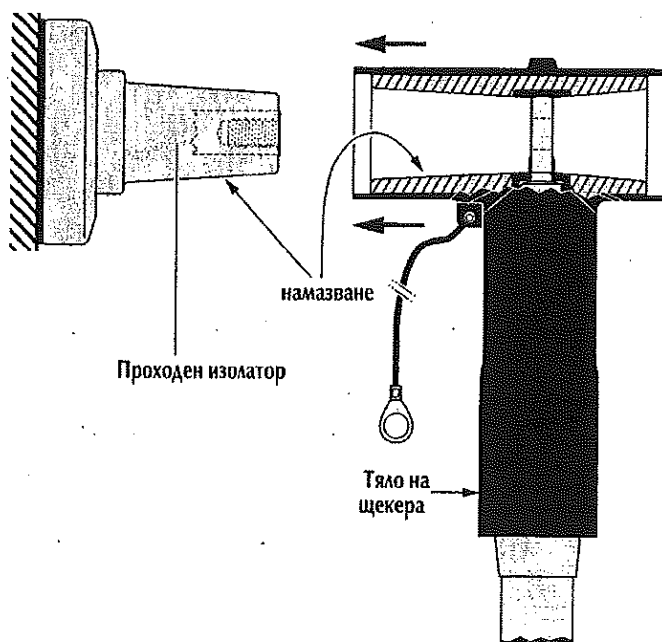

ВЯРНО
ОРИГИНАЛ

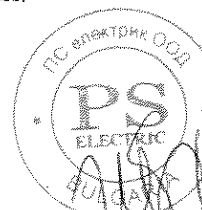

ВНИМАНИЕ!

Преди поставянето на щекера да се премахне временното закрепване на кабела!

- 1 Проходният изолатор и щекерът се проверяват и ако е необходимо се почистват, след което се намазват със силиконовата смазка*.
- 2 Тялото на щекера се напъхва върху изолатора.

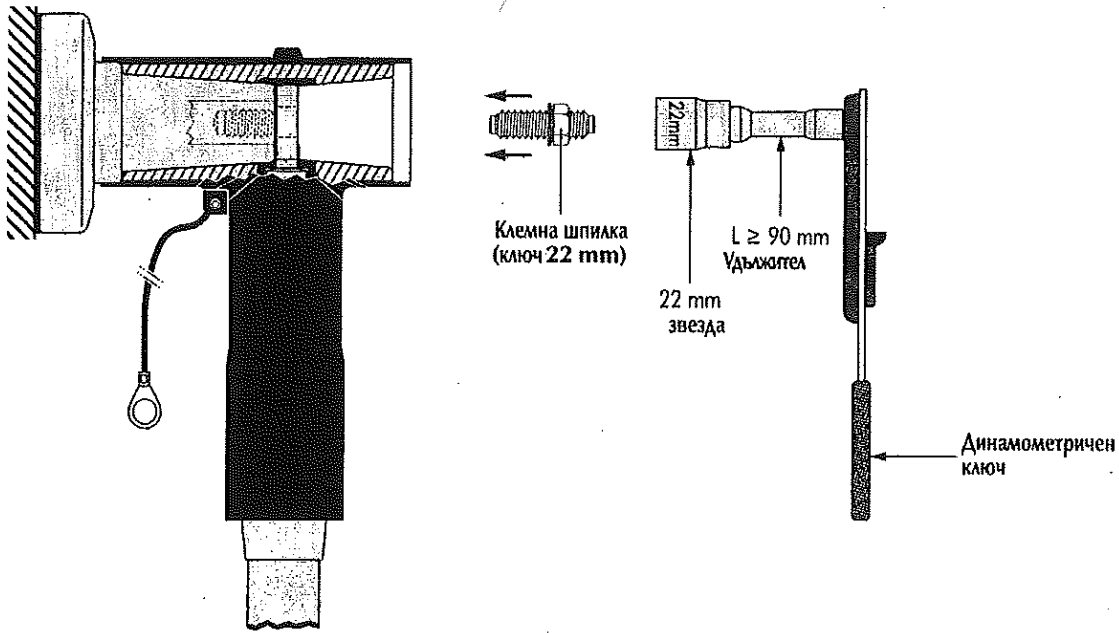

- 3 Клемн. шпика се затяга с динамом. ключ, удължител и звезда 22 mm (момент на затягане: 50 Nm).
Важно: За да се постигне правилния момент на затягане, не бива да има смазка по навивките на резбата.
- 4 При завиването да се внимава, да не се усуче щекера.

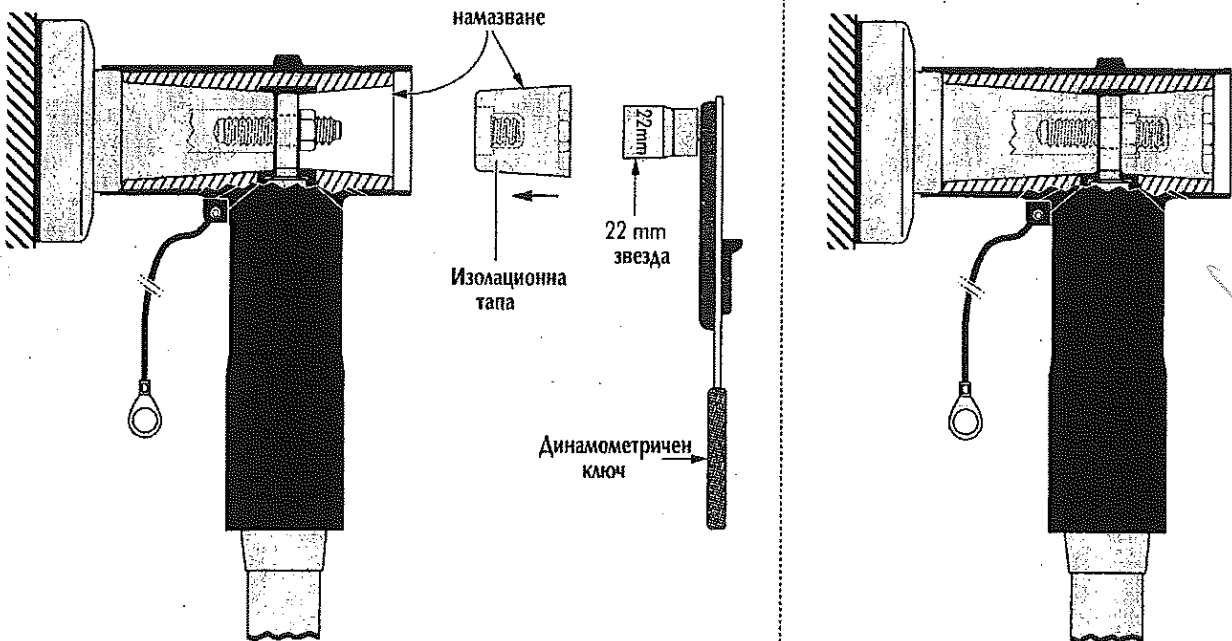

- 5 Изоляционната тапа се почиства добре и заедно с вътрешната страна на щекера се намазват със силиконовата смазка. След това се завива с динамометричен ключ и звезда 22 mm (момент на завиване: 30 Nm).
Важно: За да се постигне правилния момент на завиване, не бива да има никаква смазка по резбата.

ВЯРНО
ОРИ

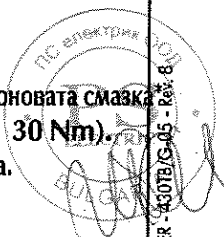

МОНТАЖ НА КАПАЧКАТА

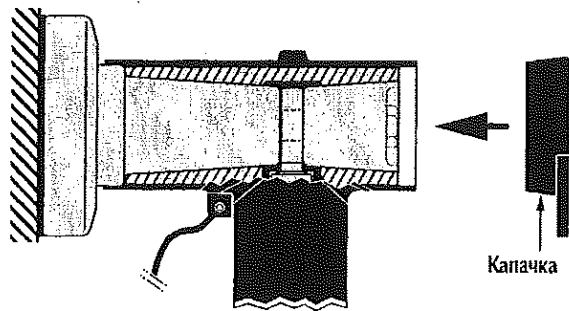

A. Монтаж на капачка без кондензаторна точка за измерване (само за приложения до 24 kV):
 Монтаж на капачката: проверява се дали са чисти щекера и капачката, в случай че е необходимо се избърсват. Силно се притиска капачката върху щекера. Въздухът под налягане се отделя чрез леко повдигане от едната страна на капачката. Фаската на капачката трябва да сочи, както е показано на чертежа.

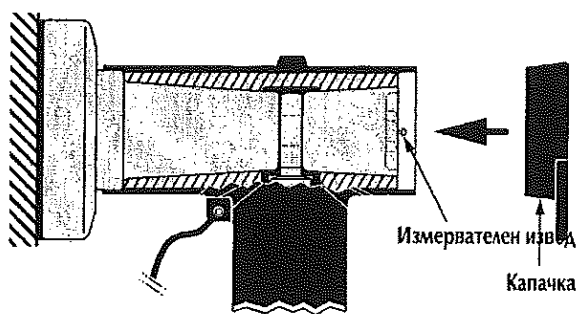

B. Монтаж на капачка с кондензаторна точка за измерване (за приложения до 36 kV):
 Монтаж на капачката: проверява се дали са чисти щекера и капачката, в случай че е необходимо се избърсват. Силно се притиска капачката върху щекера, това означава с палец да се натисне капачката в средата, докато се фиксира винта. Въздухът под налягане се отделя чрез леко повдигане от едната страна на капачката. Фаската на капачката трябва да сочи, както е показано на чертежа.

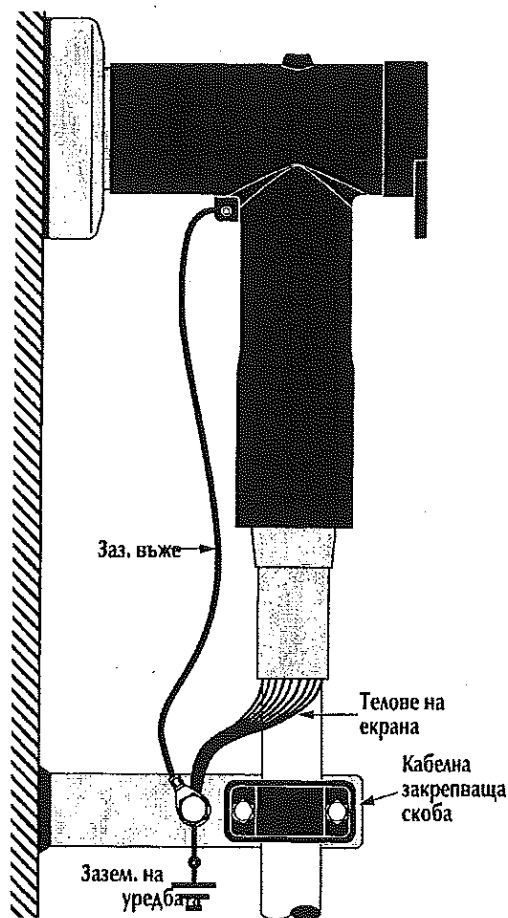

- 1 Теловите на екрана се захващат заедно.
- 2 Теловите на екрана и заземителното въже се свързват със заземяването на уредбата. При поставянето на скобата върху кабела, да се внимава щекерът да е върху външния конус без напрежение.

ВНИМАНИЕ:

Системата щекер - проходен изолатор не е оразмерена да носи тежестта на кабела. Затова е необходимо допълнително да се укрепи кабела под щекера.

ВАЖНИ УКАЗАНИЯ:

- Щекерът никога не трябва да се включва под напрежение без да е надежно завита клемната щифт.
- Опасно за живота е щекерът да се разединява под напрежение!
- Да не допуска контакт на щекера с разтворители и масла на въглеродородна основа. В случай на такъв контакт, щекерът старателно да се почисти със суха кърпа.

ВЯРНС

ОФИС